



EGLO
my light | my style



2019/20

OUTDOOR LUMINAIRES

AUSSENLEUCHTEN
LUMINAIRES EXTÉRIEURS



Dear customers and business partners,
our loyal EGLO friends,

we are happy to present our new 2020 outdoor luminaire catalogue. You can find matching luminaires for your garden, balcony, garage, carport, or entrance area here - create an atmosphere of cosiness around your house.

No matter if you prefer decorative or functional, classic or modern, simple or immediately visible lighting solutions – we have the matching luminaire for any taste. The "Safety & Comfort" product lines with motion sensors and our Smart Light Bluetooth System "connect" are important parts of our innovative outdoor lamp range.

Have fun browsing our catalogue!

Geschätzte Kunden und Geschäfts-
partner, treue EGLO-Freunde,

wir freuen uns, Ihnen den neuen Außenleuchtenkatalog 2020 präsentieren zu können. Hier finden Sie passende Leuchten für Ihren Garten, Balkon, Garage, Carport oder den Eingangsbereich - schaffen Sie sich eine Wohlfühlatmosphäre rund um Ihr Haus.

Ob dekorativ oder funktionell, klassisch oder modern, schlicht oder auffällig – für jeden Geschmack ist die passende Leuchte dabei. Auch weiterhin sind die Produktlinien „Safety & Comfort“ mit Bewegungssensoren sowie unser Smart Light Bluetooth System „connect“ wichtige Bestandteile unseres innovativen Außenleuchtersortiments.

Viel Vergnügen beim Durchstöbern unseres Kataloges!

Chers clients, chers partenaires com-
merciaux, chers amis d'EGLO,

nous avons le plaisir de vous présenter le nouveau catalogue de luminaires extérieurs 2020. Ici, vous trouverez des luminaires adaptés à votre jardin, balcon, garage, abri voiture ou zone d'entrée - créez une atmosphère de bien-être autour de votre maison.

Qu'il soit décoratif ou fonctionnel, classique ou moderne, sobre ou frappant – il y a des luminaires pour tous les goûts. Les lignes de produits « Safety & Comfort » avec capteurs de mouvement et notre système Bluetooth de lumière intelligente « connect » restent des parties intégrantes importantes de notre gamme innovante de luminaires extérieurs.

Nous vous souhaitons beaucoup de plaisir en feuilletant notre catalogue !



Mag. René Tiefenbacher
CEO EGLO Group



CONTENTS

INHALT
CONTENU



EGLO CONNECT

4-23



TOPLINE

102-115



SAFETY & COMFORT

24-33



CLASSIC

KLASSIK
CLASSIQUE

116-159



MODERN

MODERN
MODERNE

34-101



SPOTS, RECESSED & ACCESSOIRES

SPOTS, EINBAULEUCHTEN & ZUBEHÖR
SPOTS, LUMINAIRES ENCASTRÉS & ACCESSOIRES

160-189



GARDEN LIVING

190-193



INDEX & LEGEND

P. 194-208

INDEX & ERKLÄRUNG
INDEX & LÉGENDE

EEL
EGLO WORLDWIDE
LEGEND
REGISTER
MEMO
IMPRESSUM

P. 194 - 195
P. 196 - 197
P. 198 - 201
P. 202 - 205
P. 206 - 207
P. 208

Light takes a
new direction:
Your direction



EGLO CONNECT

OVERVIEW

EGLO CONNECT



EGLO CONNECT
13



CONNECT REMOTE
14



LOCANA-C
14



PIOVE-C
14



LOCANA-C
14



CONNECT SENSOR
14



ARGOLIS-C
15



ARGOLIS-C
15



TORAZZA-C
16



MARCHESA-C
17



FRANCARI-C
17



LM_LED_E27
18



VERRES-C
18



CALDIERO-C
19



NISIA-C
20



MONTEROLO-C
22



NEMA 1-C
23



EGLO CONNECT
23



LM_LED_GU10
23



1



Luminaire / Bulb
Leuchte / Leuchtmittel
Luminaire / Ampoules

2



Remote Control / App
Fernbedienung / App
Télécommande / App



3

LET'S GO!!!

EASY, SMART & SAFE

EINFACH, INTELLIGENT & SICHER
SIMPLE, INTELLIGENT ET SÛR

If you're looking for easy installation and uncomplicated devices, EGLO connect is the right place for you.

Suchst du leichte Installationen und unkomplizierte Geräte - dann bist du bei EGLO connect genau richtig.

Des installations aisées et des appareils simples – EGLO connect est le bon dispositif pour toi.

Starting is made quick and easy, you only need two components:

Der Einstieg ist schnell und einfach, du benötigst nur zwei Komponenten:

Les premiers pas sont simples et rapides, tu as besoin de deux objets :

- › An EGLO connect luminaire / illuminant
- › An EGLO connect remote control or the free AwoX Smart control App

- › Eine EGLO connect Leuchte / Leuchtmittel
- › Eine EGLO connect Fernbedienung oder die kostenlose AwoX Smart control App

- › Une lampe / ampoule EGLO connect
- › Une télécommande EGLO connect ou l'application gratuite AwoX Smart control

You'll be set to start immediately then!

Schon kann's losgehen!

Prêt à te lancer!

The system's basic advantages are:

Die grundlegenden Vorteile des Systems sind:

Les avantages primordiaux du système sont:



Simple installation

EGLO connect products use Bluetooth technology and do not need any elaborate installations.

Einfache Installation

EGLO connect Produkte verwenden die Bluetooth Technologie und benötigen keine aufwändigen Installationen.

Une installation simple

Les produits EGLO connect emploient la technologie Bluetooth et ne nécessitent pas d'installations complexes.



Smart technology

The EGLO connect items communicate with each other to form a smart, expandable network (MESH technology).

Smarte Technologie

Die EGLO connect Artikel kommunizieren miteinander und bilden ein intelligentes, erweiterbares Netzwerk (MESH-Technologie).

Une technologie intelligente

Les articles EGLO connect communiquent les uns avec les autres et forment un réseau intelligent et extensible (technologie MESH).



Protected network

All EGLO connect products in your home form a closed network and are secured against third-party access.

Geschütztes Netzwerk

Alle EGLO connect Produkte in deinem Zuhause bilden ein geschlossenes Netzwerk und sind vor fremdem Zugriff gesichert.

Un réseau protégé

Tous les produits EGLO connect dans ton foyer forment un réseau fermé et sont ainsi protégés des accès étrangers.

Q BASIC USER

Kein Wlan / Internet notwendig.
Steuerbar mit Fernbedienung.

No WLAN / internet necessary.
Controllable via a remote control.

Pas de Wifi / Internet nécessaire.
Commandable par télécommande.



Q ADVANCED USER

Internetverbindung wird nur zur App Installation, Registrierung und für Updates benötigt.

Steuerbar mit Smartphone / Tablet (App) und Fernbedienung.

Einbindung eines batteriebetriebenen Sensors mit Day & Night Funktion und Bewegungserkennung möglich.

Internet connection only needed for the installation of the app, registration and updates.

Controllable via smartphone / tablet (app) and remote control.

Integration of a battery-operated sensor with Day & Night function and motion detection possible.

Connexion Internet requise uniquement pour l'installation de l'appli, l'enregistrement et les mises à jour.

Commandable avec Smartphone / Tablette (appli) et télécommande.

Intégration d'un capteur à batteries avec fonction « Jour et nuit » et détection de mouvement possible.



Q POWER USER

Du nutzt das volle Potential von EGLO connect.

Der PLUG PLUS ermöglicht es mithilfe von Alexa, Google Home und deinem Smartphone/Tablet das System von Zuhause oder unterwegs zu steuern.

You use the full potential of EGLO connect.

The PLUG PLUS allows Alexa, Google Home and your smartphone / tablet to control the system from home or on the road.

Vous utilisez tout le potentiel d'EGLO connect.

Le connecteur PLUS permet à Alexa, Google Home et votre Smartphone / Tablette, de commander le système connect de chez vous ou à distance.

GROWS & LEARNS

WÄCHST & LERNT
APPRENDRE ET ÉVOLUER

EGLO connect grows to match your needs:

BASIC USER:

Use the EGLO connect remote control together with the EGLO connect lamps / luminaires to adjust brightness, colours and mood. These functions are practical, easy to handle and will meet your daily needs.

ADVANCED USER:

Use the App and expand your options: Combine living areas into groups to control lighting and other devices practically and quickly. Add to the experience of a movie night with the matching light scenario.

POWER USER:

Use the full potential of EGLO connect and the PLUG PLUS: Away from-Home control by integration in your WiFi, control by speech commands via Amazon Echo and Google Home, Day & Night function including motion detection and much more – the future of lighting in your home.

EGLO connect wächst mit deinen Bedürfnissen:

BASIC USER:

Du nutzt die EGLO connect Fernbedienung zusammen mit den EGLO connect Leuchtmitteln / Leuchten. Damit stellst du Helligkeit, Farbe und Stimmung ein. Diese Funktionen sind praktisch, einfach zu handhaben und genügen deinen täglichen Bedürfnissen.

ADVANCED USER:

Du nutzt die App und erweiterst deinen Spielraum: Fasse Wohnbereiche zu Gruppen zusammen, um Licht und andere Geräte praktisch und schnell ansteuern zu können. Verstärke das Erlebnis eines Filmabends mit dem passenden Lichtszenario.

POWER USER:

Du nutzt das volle Potential von EGLO connect und dem PLUG PLUS. Away from-Home control durch Intergration in dein W-Lan, Steuerung per Sprachbefehl mit Hilfe von Amazon Echo und Google Home, Day & Night Funktion inklusive Bewegungserkennung und vieles mehr – Lichtzukunft in deinem Heim.

EGLO connect évolue avec tes besoins:

UTILISATEUR DE BASE:

Tu utilises la télécommande EGLO connect conjointement avec les ampoules/luminaires EGLO connect. Tu régles ainsi la luminosité, la couleur et l'ambiance. Ces fonctions sont pratiques, faciles à manier et suffisent à tes besoins au quotidien.

UTILISATEUR AVANCÉ:

Tu utilises l'application et accrois ta marge de manoeuvre : tu rassembles des zones d'habitat en des groupes afin de pouvoir commander la lumière et les autres appareils de manière rapide et pratique. Renforces l'ambiance d'une soirée film par la scénérie lumineuse correspondante.

UTILISATEUR PUISSANT:

Tu utilises l'ensemble du potentiel d'EGLO connect et PLUG PLUS. Un contrôle hors de chez toi par l'intégration dans ton Wi-Fi, un pilotage par commande vocale avec Amazon Echo et Google Home, une fonction jour & nuit avec détection de mouvements et bien d'autres choses - l'avenir de l'éclairage dans ta maison.



FUNCTION & CONTROL

FUNKTION & BEDIENUNG FONCTION ET COMMANDE



Connect Sensor
Connect Sensor
Capteur Connect



Remote control
Fernbedienung
Télécommande



App control
App
App



CONNECT
PLUG



CONNECT
PLUG PLUS



Functions Funktionen Fonctions

Basic functions / Grundfunktionen / Fonctions de base

Activation / deactivation Ein- / Ausschalten Allumer / éteindre		•	•	•	•
Motion sensor Bewegungssensor Capteur de mouvements	•				
Light colour regulation Lichtfarben regulieren Réguler les teintes lumineuses		16,7 Mio.	16,7 Mio.		16,7 Mio.
Smooth dimming* Stufenloses Dimmen* Graduation continue*		•	•		
Voice control Sprachsteuerung Commande par la voix					•

Comfort functions / Komfortfunktionen / Fonctions confort

Pre-set scenarios Voreingestellte Szenarien Scéneries prédéfinies			•		
Saving favourites Favoriten speichern Sauvegarder les favoris		2	4		
Grouping lamps Leuchten gruppieren Regroupement des luminaires			•		
Programming function (on / off) Programmierfunktion (Ein / Aus) Fonction de programmation (marche / arrêt)			•	•	•
Dawn simulation Dämmerungssimulation Simulation de crépuscule			•		
Timer function Timer-Funktion Fonction de minuterie			•	•	•
Day & night function Tag & Nacht-Funktion Fonction jour & nuit	•				
Night light Nachtlicht Veilleuse de nuit			•		
Names & pictures for luminaires Namen & Bilder für Leuchten Noms et photos pour les luminaires			•		
Disco function Diskofunktion Fonction disco			•		
BLE Smart Meter function BLE Smart Meter Funktion BLE Fonction smart meter				•	•

* for EGLO connect luminaires / bulbs only - nur für EGLO connect Leuchten / Leuchtmittel - seulement pour luminaires / ampoules EGLO connect



ADVANTAGES OF THE CONNECT SENSOR

IP44 Safety no cabling necessary

The CONNECT SENSOR is battery-operated, so that no difficult cabling is necessary. The sensor can be mounted directly on the wall. With the mounting bracket (included in the delivery), you can easily adjust the detection range to your needs. This permits fine adjustment by 30 degrees to the left and right.

Night mode

When Night mode is enabled the luminaires receive the indication night or day from the CONNECT SENSOR. Choose from 3 sensitivity settings (25 to 75%).

Night movement detection

When Night movement detection is enabled the CONNECT SENSOR turns on the luminaires with the chosen light intensity when movement is detected. You can choose from 3 movement detection sensitivity settings. The light will turn off after the selected time when no movement is detected.

Combination of Night mode and Night movement detection

VORTEILE DES CONNECT SENSOR

IP44 Schutz Keine Verkabelung notwendig

Der CONNECT SENSOR ist batteriebetrieben, so dass keine schwierige Verkabelung erforderlich ist. Der Sensor kann direkt an die Wand montiert werden. Mit der Montagehalterung (im Lieferumfang enthalten) können Sie den Erfassungsbereich ganz einfach an Ihre Bedürfnisse anpassen. Dadurch ist eine Feinjustierung von 30 Grad nach links und rechts möglich.

Night mode

Wenn der Nachtmodus aktiviert ist, erhalten die Leuchten die Anzeige Nacht oder Tag vom CONNECT SENSOR. Wählen Sie aus 3 Empfindlichkeitseinstellungen (25 bis 75%).

Night movement detection

Wenn die Nachtbewegungserkennung aktiviert ist, schaltet der CONNECT SENSOR die Leuchten mit der gewählten Lichtintensität ein, wenn die Bewegung erkannt wird. Sie können aus 3 Bewegungserkennungssensibilitätseinstellungen wählen. Das Licht schaltet sich nach der gewählten Zeit aus, wenn keine Bewegung erkannt wird.

Kombination von Night mode und Night movement detection

ADVANTAGES DE LA CAPTEUR CONNECT

Protection IP44 Aucun câble nécessaire

Le CONNECT SENSOR est alimenté par batterie, donc aucun câblage difficile n'est nécessaire. Avec le support de montage (inclus dans la livraison), vous pouvez facilement ajuster l'étendue de la détection à vos besoins. Ce réglage fin de 30 degrés à gauche et à droite est possible.

Mode de nuit (Night mode)

Lorsque le mode de nuit est activé, les luminaires reçoivent l'indication du jour ou de la nuit du capteur CONNECT. Choisissez parmi 3 réglages de sensibilité (de 25 à 75%).

Détection de mouvement nocturne

Lorsque la détection de mouvement nocturne est activée, le CONNECT SENSOR allume les luminaires avec l'intensité lumineuse choisie lorsqu'un mouvement est détecté. Vous pouvez choisir parmi 3 réglages de sensibilité de détection de mouvement. Si aucun mouvement n'est détecté, la lumière s'éteindra après la période sélectionnée.

Combinaison du mode de nuit et de la détection de mouvement nocturne



Im Set
erhältlich
inkl.
Remote



11585 EGLO CONNECT

illuminant; plastic
Leuchtmittel; Kunststoff
ampoule; plastique

L 118, Ø 60



EGLO CONNECT ILLUMINANT

One illuminant – numerous possibilities: 16.7 million colours and over 50,000 white tones ensure the right atmosphere in your home at all times. The illuminant can be controlled via remote control or app using Bluetooth technology: You can control the brightness or adjust colour tones – and all this without complicated installation and comfortably from the sofa.

But the illuminant can do much more: it can be expanded at will using intelligent mesh technology, and up to 50 illuminants can be grouped together. This makes it easy to create and program a wide variety of lighting scenarios. You can also use the app to select from a large number of pre-set lighting scenes.

Security is not neglected either, as the illuminants form a self-contained network and are therefore protected from external access.

EGLO CONNECT LEUCHTMITTEL

Ein Leuchtmittel – zahlreiche Möglichkeiten: 16,7 Millionen Farben und über 50.000 Weißtöne sorgen jederzeit für die richtige Stimmung in Ihrem Heim. Über die Bluetooth-Technologie kann das Leuchtmittel per Fernbedienung oder App gesteuert werden: Sie können die Helligkeit kontrollieren oder Farbtöne einstellen – und das alles ohne aufwändige Installation und bequem vom Sofa aus.

Aber das Leuchtmittel kann noch viel mehr: es lässt sich per intelligenter Mesh-Technologie beliebig erweitern, bis zu 50 Leuchtmittel sind hierbei gruppierbar. So lassen sich problemlos und einfach unterschiedlichste Lichtszenarien erstellen und programmieren. Mit der App können Sie aber auch aus einer Vielzahl vorgegebener Lichtstimmungen auswählen.

Auch die Sicherheit kommt nicht zu kurz, denn die Leuchtmittel bilden ein in sich geschlossenes Netzwerk und sind somit vor Zugriffen von Außen geschützt.

AMPOULE EGLO CONNECT

Une seule ampoule – de nombreuses possibilités : 16,7 millions de couleurs et plus de 50 000 tons de blanc assurent à tout moment la bonne ambiance dans votre maison. L'ampoule peut être commandée via une télécommande ou une appli, utilisant la technologie Bluetooth : Vous pouvez contrôler la luminosité ou régler les tons de couleurs – et tout cela sans installation compliquée et de manière confortablement depuis votre canapé.

Mais l'ampoule peut faire beaucoup plus : elle peut être étendue à volonté grâce à la technologie Mesh intelligentes, et jusqu'à 50 ampoules peuvent être regroupées. Il est ainsi facile de créer et de programmer une grande variété de scène lumineuse. Vous pouvez également utiliser l'appli pour sélectionner un grand nombre d'ambiance lumineuse prédéfinies.

La sécurité n'est pas négligée non plus, car les ampoules forment un réseau fermé et sont donc protégées des accès externes.



32732 CONNECT REMOTE

remote control; plastic, white
Fernbedienung; Kunststoff, weiss
télécommande; plastique, blanc

L 110, B 53, H 20

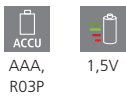

97475 CONNECT SENSOR

accessory; plastic, white
Zubehör; Kunststoff, weiss
accessoire; plastique, blanc

L 60, H 60, A 40

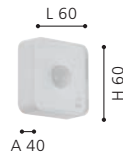
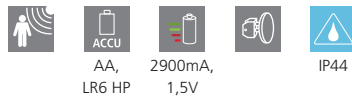

97475

With the mounting bracket (included in the delivery), you can easily adjust the detection range to your needs. This permits fine adjustment by 30 degrees to the left and right.

Mit der Montagehalterung (im Lieferumfang enthalten) können Sie den Erfassungsbereich ganz einfach an Ihre Bedürfnisse anpassen. Dadurch ist eine Feinjustierung von 30 Grad nach links und rechts möglich.

Avec le support de montage (inclus dans la livraison), vous pouvez facilement ajuster l'étendue de la détection à vos besoins. Ce réglage fin de 30 degrés à gauche et à droite est possible.



97295 PIOVE-C

wall / ceiling light; cast aluminium, black / plastic, white
Wand- / Deckenleuchte; Aluguss, schwarz / Kunststoff, weiss
applique / plafonnier; fonte d'aluminium, noir / plastique, blanc

L 250, H 250, A 80



97237 LOCANA-C

wall / ceiling light; zinc-plated steel, anthracite / plastic, white
Wand- / Deckenleuchte; Stahl verzinkt, anthrazit / Kunststoff, weiss
applique / plafonnier; acier galvanisé, anthracite / plastique, blanc

H 95, Ø 260

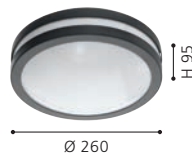

97299 LOCANA-C

wall / ceiling light; zinc-plated steel, silver / plastic, white
Wand- / Deckenleuchte; Stahl verzinkt, silber / Kunststoff, weiss
applique / plafonnier; acier galvanisé, argent / plastique, blanc

H 95, Ø 260





98172 ARGOLIS-C

wall / ceiling light; cast aluminium, white / plastic, white
Wand- / Deckenleuchte; Aluguss, weiss / Kunststoff, weiss
applique / plafonnier; fonte d'aluminium, blanc / plastique, blanc

L 300, B 300, H 35



22W 2600lm IP44

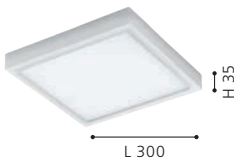

98171 ARGOLIS-C

wall / ceiling light; cast aluminium, white / plastic, white
Wand- / Deckenleuchte; Aluguss, weiss / Kunststoff, weiss
applique / plafonnier; fonte d'aluminium, blanc / plastique, blanc

H 35, Ø 225

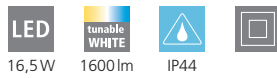

16,5W 1600lm IP44

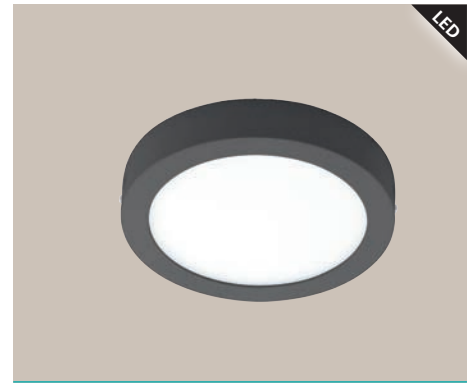
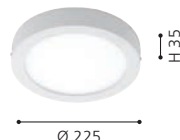

98173 ARGOLIS-C

wall / ceiling light; cast aluminium, anthracite / plastic, white
Wand- / Deckenleuchte; Aluguss, anthrazit / Kunststoff, weiss
applique / plafonnier; fonte d'aluminium, anthracite / plastique, blanc

H 35, Ø 225

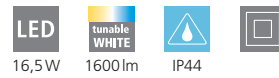

16,5W 1600lm IP44



98174 ARGOLIS-C

wall / ceiling light; cast aluminium, anthracite / plastic, white
Wand- / Deckenleuchte; Aluguss, anthrazit / Kunststoff, weiss
applique / plafonnier; fonte d'aluminium, anthracite / plastique, blanc

L 300, B 300, H 35



22W 2600lm IP44

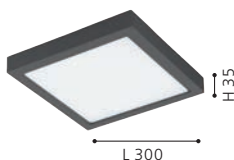

98172



97219



97219 TORAZZA-C

wall light; plastic, steel, anthracite / plastic, satined
 Wandleuchte; Kunststoff, Stahl, anthrazit / Kunststoff, satiniert
 applique; plastique, acier, anthracite / plastique, satiné

L 215, H 215, A 70



14W 1400lm IP44



1x 3x
 A-F 0-9

97219

Letters and numbers included in delivery.

Buchstaben und Zahlen im Lieferumfang enthalten.

Les lettres et les nombres sont inclus dans la livraison.



97219

This luminaire is delivered with freely positionable ornamental elements which are attached by means of adhesive tape.

Diese Leuchte wird mit frei positionierbaren Zierelementen geliefert, welche mittels Klebeband angebracht werden.

Ce luminaire est livrée avec éléments de décoration qui sont attachés au moyen du ruban adhésif.



98234 FRANCARI-C

wall light; cast aluminium, black / plastic, white
Wandleuchte; Aluguss, schwarz / Kunststoff, weiss
applique; fonte d'aluminium, noir / plastique, blanc

L 220, H 255, A 250



98145 MARCHESA-C

wall / ceiling light; stainless steel, stainless steel / plastic, white
Wand- / Deckenleuchte; Edelstahl, edelstahl / Kunststoff, weiss
applique / plafonnier; acier inoxydable, acier inoxydable / plastique, blanc

H 70, Ø 300



98145

Letters and numbers included in delivery.

Buchstaben und Zahlen im Lieferumfang enthalten.

Les lettres et les nombres sont inclus dans la livraison.

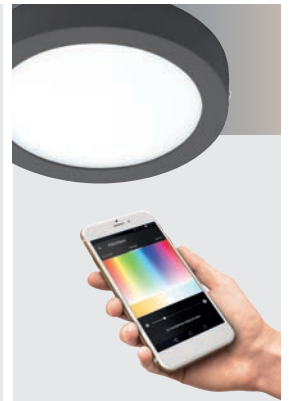

EGLO connect

Our EGLO connect outdoor lamps withstand any weather condition. They offer an attractive complimentary package, together with our indoor lamps.

Unsere EGLO connect Außenleuchten halten jeder Witterung stand und bilden zusammen mit unseren Innenleuchten ein attraktives Gesamtpaket.

Nos luminaires extérieurs EGLO connect résistent à toute intempérie et forment communément avec nos luminaires intérieurs un ensemble attrayant.



98145



11684 LM_LED_E27

illuminant; plastic, opal
 Leuchtmittel; Kunststoff, opal
 ampoule; plastique, opale

L 118, Ø 60

E27	1x 9W	3000K	25000h	
220-240V, 50/60Hz	15000x	>80		

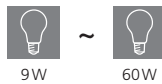

97239 VERRES-C

wall light; stainless steel, plastic, stainless steel, white / plastic, white
 Wandleuchte; Edelstahl, Kunststoff, edelstahl, weiss / Kunststoff, weiss
 applique; acier inoxydable, plastique, acier inoxydable, blanc / plastique, blanc

L 180, H 290, A 90

E27	1x 9W	1x 806lm	IP44	





EGLO CONNECT E27

The EGLO connect E27 lamp 11684 is included in the delivery of all luminaires on pages 18 to 20.

Das EGLO connect E27 Leuchtmittel 11684 ist bei allen Leuchten auf den Seiten 18 bis 20 im Lieferumfang inkludiert

L'ampoule EGLO E27 connect de référence 11684 est livrée avec tous les luminaires des pages 18 à 20.

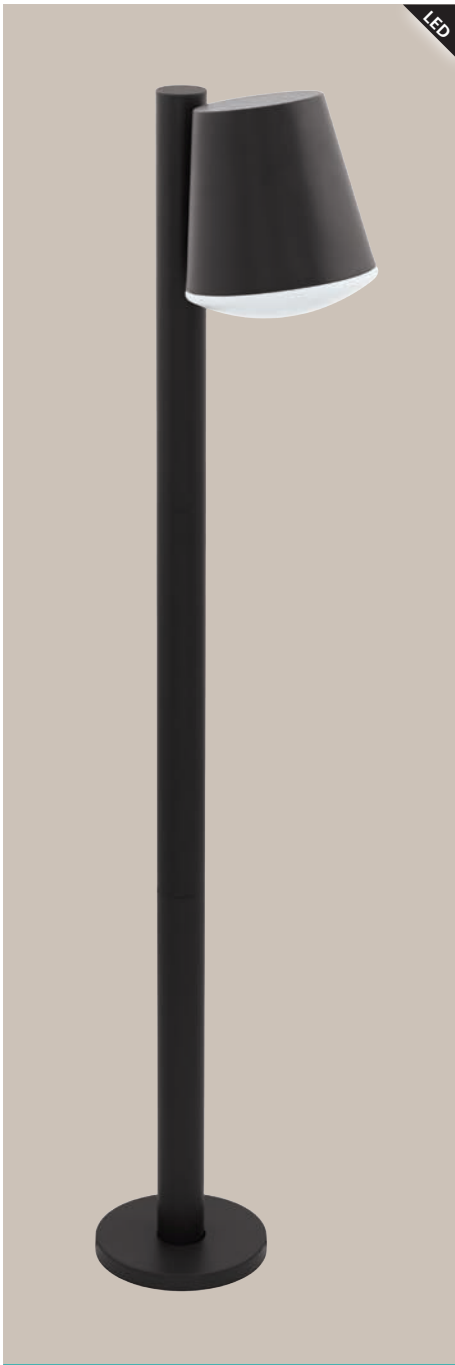



LED

97483 CALDIERO-C

floor light; zinc-plated steel, anthracite / plastic, white
 Stehleuchte; Stahl verzinkt, anthrazit / Kunststoff, weiss
 lampadaire; acier galvanisé, anthracite / plastique, blanc

L 240, B 140, H 965, Base: Ø 140

- E27
- 1x 9W
- warm WHITE 1x 806lm
- IP44

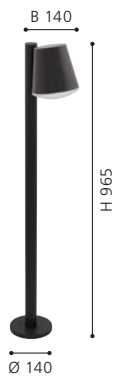

9 002759 974831

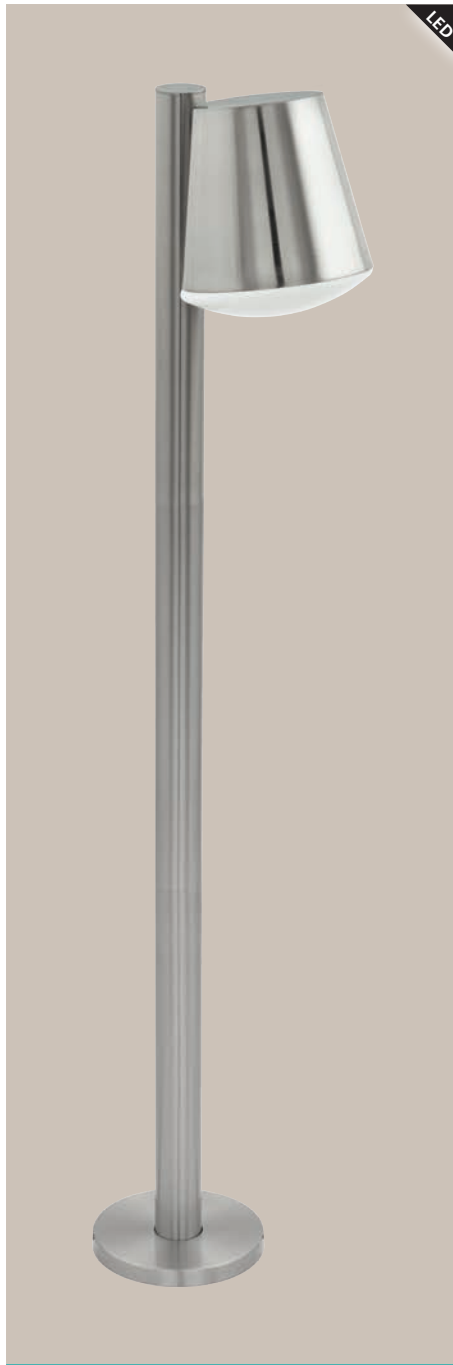

LED

97485 CALDIERO-C

floor light; stainless steel, stainless steel / plastic, white
 Stehleuchte; Edelstahl, edelstahl / Kunststoff, weiss
 lampadaire; acier inoxydable, acier inoxydable / plastique, blanc

L 240, B 140, H 965, Base: Ø 140

- E27
- 1x 9W
- warm WHITE 1x 806lm
- IP44



9 002759 974855



LED

97482 CALDIERO-C

wall light; zinc-plated steel, anthracite / plastic, white
 Wandleuchte; Stahl verzinkt, anthrazit / Kunststoff, weiss
 applique; acier galvanisé, anthracite / plastique, blanc

L 140, H 240, A 190

- E27
- 1x 9W
- warm WHITE 1x 806lm
- IP44



9 002759 974824



LED

97484 CALDIERO-C

wall light; stainless steel, stainless steel / plastic, white
 Wandleuchte; Edelstahl, edelstahl / Kunststoff, weiss
 applique; acier inoxydable, acier inoxydable / plastique, blanc

L 140, H 240, A 190

- E27
- 1x 9W
- warm WHITE 1x 806lm
- IP44



9 002759 974848



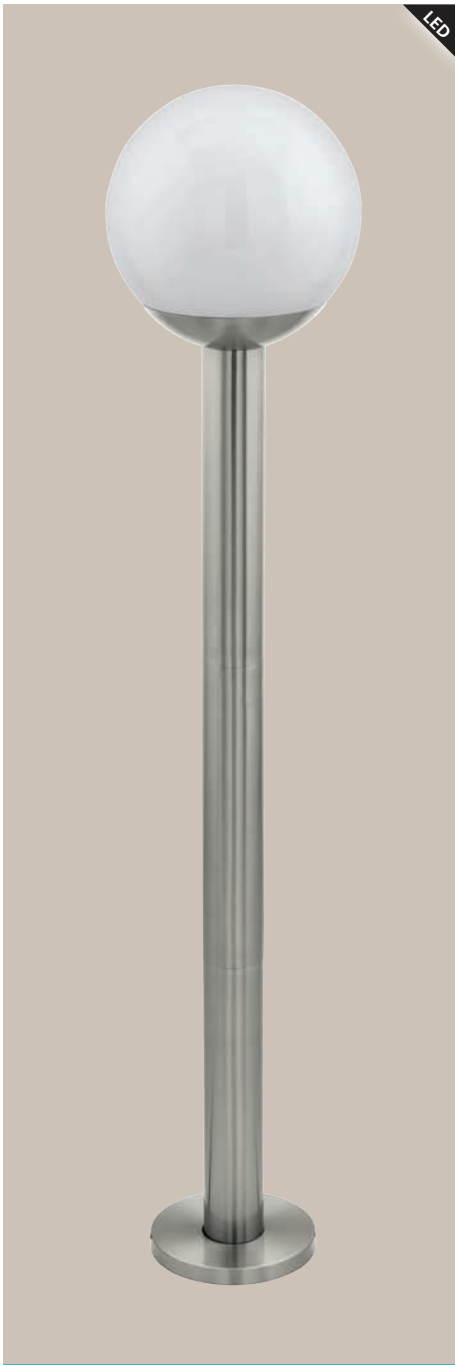

97249 NISIA-C

floor light; stainless steel, stainless steel / plastic, white
 Stehleuchte; Edelstahl, edelstahl / Kunststoff, weiss
 lampadaire; acier inoxydable, acier inoxydable / plastique, blanc

H 980, Ø 200, Base: Ø 140

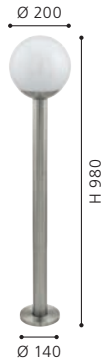
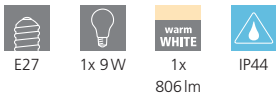

97248 NISIA-C

pedestal light; stainless steel, stainless steel / plastic, white
 Sockelleuchte; Edelstahl, edelstahl / Kunststoff, weiss
 luminaire pour socle; acier inoxydable, acier inoxydable / plastique, blanc

H 525, Ø 200, Base: Ø 140

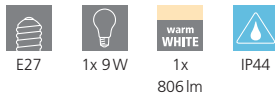

97247 NISIA-C

wall light; stainless steel, stainless steel / plastic, white
 Wandleuchte; Edelstahl, edelstahl / Kunststoff, weiss
 applique; acier inoxydable, acier inoxydable / plastique, blanc

L 200, H 315, A 220

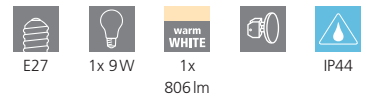



97247



LED

98105 MONTEROLO-C

floor light; plastic, white / plastic, white
 Stehleuchte; Kunststoff, weiss / Kunststoff, weiss
 lampadaire; plastique, blanc / plastique, blanc

H 300, Ø 300, Base: Ø 120

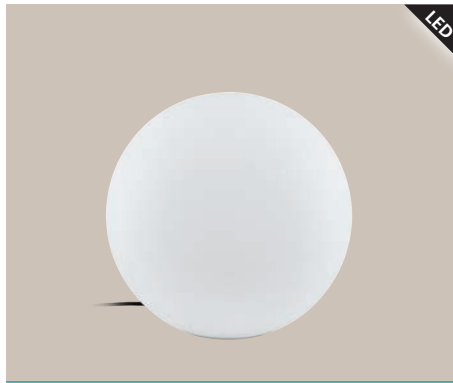
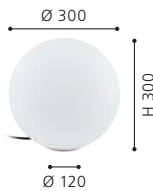
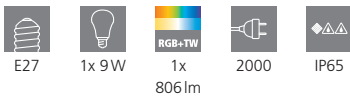

LED

98106 MONTEROLO-C

floor light; plastic, white / plastic, white
 Stehleuchte; Kunststoff, weiss / Kunststoff, weiss
 lampadaire; plastique, blanc / plastique, blanc

H 390, Ø 390, Base: Ø 195

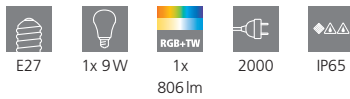

LED

98107 MONTEROLO-C

floor light; plastic, white / plastic, white
 Stehleuchte; Kunststoff, weiss / Kunststoff, weiss
 lampadaire; plastique, blanc / plastique, blanc

H 500, Ø 500, Base: Ø 195

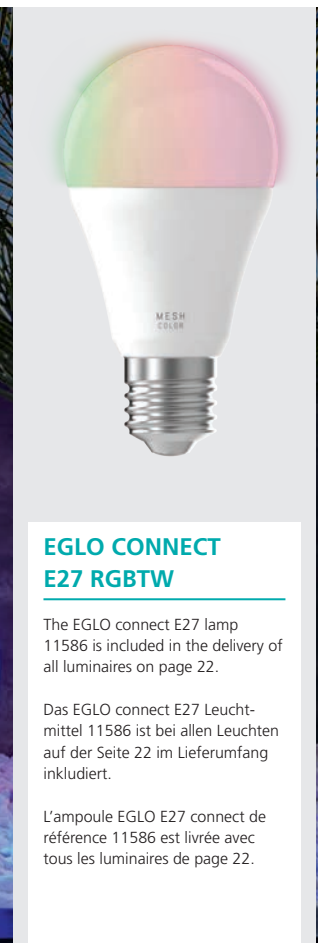
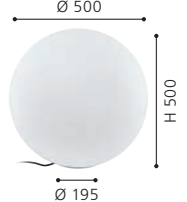
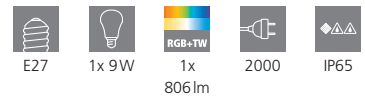

EGLO CONNECT E27 RGBTW

The EGLO connect E27 lamp 11586 is included in the delivery of all luminaires on page 22.

Das EGLO connect E27 Leuchtmittel 11586 ist bei allen Leuchten auf der Seite 22 im Lieferumfang inkludiert.

L'ampoule EGLO E27 connect de référence 11586 est livrée avec tous les luminaires de page 22.

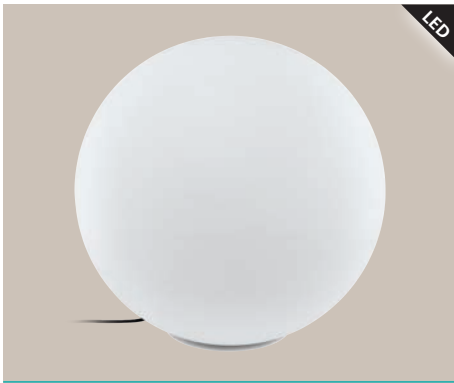

LED

98108 MONTEROLO-C

floor light; plastic, white / plastic, white
Stehleuchte; Kunststoff, weiss / Kunststoff, weiss
lampadaire; plastique, blanc / plastique, blanc

H 600, Ø 600, Base: Ø 195

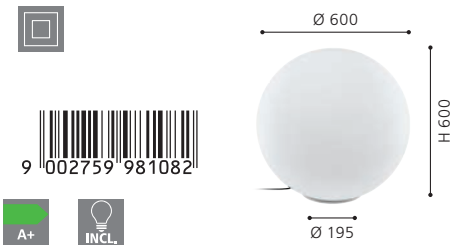
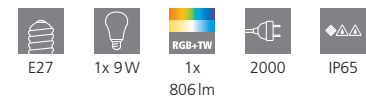

98052 NEMA 1-C

ground spike; plastic, black / plastic, transparent
Erdspieß; Kunststoff, schwarz / Kunststoff, transparent
piquet de terre; plastique, noir / plastique, transparent

L 130, B 60, H 245

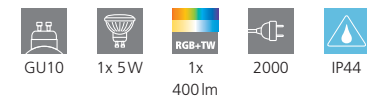

LED

400 lm

5 year warranty
5 Jahre Garantie
5 anni de garantie
5 años de garantía

11671 GU10-LED-RGBTW

illuminant; aluminium, plastic, grey / plastic, clear
Leuchtmittel; Alu, Kunststoff, grau / Kunststoff, klar
ampoule; aluminium, plastique, gris / plastique, clair

L 68, Ø 50

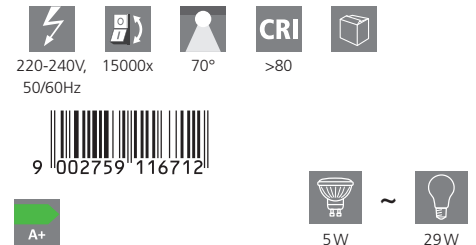

LED

806 lm

5 year warranty
5 Jahre Garantie
5 anni de garantie
5 años de garantía

11586 E27-LED-RGBTW-A60

illuminant; plastic
Leuchtmittel; Kunststoff
ampoule; plastique

L 118, Ø 60

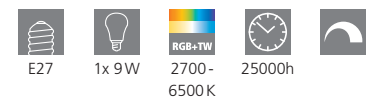

98052



EGLO CONNECT GU10 RGBTW

The EGLO connect GU10 lamp 11671 is included in the delivery of 98052 on page 23.

Das EGLO connect GU10 Leuchtmittel 11671 ist bei 98052 auf der Seite 23 im Lieferumfang inkludiert.

L'ampoule EGLO GU10 connect de référence 11671 est livrée avec tous 98052 de page 23.

SAFETY & COMFORT





SAFETY & COMFORT



Light at the right time

Smart light activated by movements offers many advantages. EGLO sensor luminaires and sensors provide you with a great deal of comfort in your daily life and increase the safety of your own four walls.

Licht zum richtigen Zeitpunkt

Smartes Licht, das durch Bewegungen aktiviert wird, bietet Ihnen viele Vorteile. Mit den Sensorleuchten und Sensoren von EGLO bringen Sie erheblichen Komfort in Ihren Alltag und erhöhen die Sicherheit rund um Ihr Zuhause.

Lumière au bon moment

Lumière intelligente, qui est activé par le mouvement, offre de nombreux avantages. Avec les lumières des capteurs et des capteurs de EGLO apporter un confort considérable dans votre vie quotidienne et d'augmenter la sécurité de vos propres quatre murs.



1. COMFORT



2. SAFETY



3. SECURITY



4. SAVE MONEY

1. COMFORT

The light comes on – without requiring you to push a button, leaving your hands free to carry your shopping bags. Come home comfortably with the sensors and sensor lamps by EGLO.

2. SAFETY

EGLO sensors and sensor lamps will show you thresholds and tripping hazards in time. Lower your accident risk in and around your home.

3. SECURITY

Motion detection will safely light up badly visible areas when this is necessary. You will always be able to see what is happening and can deter unbidden guests with the EGLO sensors and sensor lamps.

4. SAVE MONEY

Sensors and sensor lamps by EGLO help you save money. Your light will only come on when it is needed, and lower the energy costs for every home.

1. KOMFORT

Das Licht geht an – ohne dass Sie einen Schalter drücken mussten und Sie haben die Hände frei, um die Einkäufe zu tragen. Kommen Sie komfortabel nach Hause mit den Sensoren und Sensorleuchten von EGLO.

2. SICHERHEIT

EGLO Sensoren und Sensorleuchten lassen Sie Schwellen und Stolperfallen rechtzeitig erkennen. Senken Sie dadurch das Unfallrisiko in und um Ihr Zuhause.

3. SCHUTZ

Durch die Erfassung von Bewegung können schlecht einsichtbare Bereiche beleuchtet werden, wenn es notwendig ist. Sehen Sie immer was passiert und schrecken Sie ungebetene Gäste mit EGLO Sensoren und Sensorleuchten ab.

4. GELD SPAREN

Sensoren und Sensorleuchten von EGLO helfen Ihnen bares Geld zu sparen. Das Licht geht nur an wenn es benötigt wird und senkt damit die Energiekosten in Ihrem Zuhause.

1. COMFORT

La lumière s’allume – sans que vous n’ayez besoin de presser un interrupteur et vous avez les mains libres pour porter les achats. Entrez confortablement chez vous avec les capteurs et les luminaires à capteurs d’EGLO.

2. SÛRETÉ

Les capteurs et les luminaires à capteurs d’EGO vous permettent de déceler d’avance les seuils et sources de trébuchement. Réduisez ainsi les risques d’accident dans et autour de votre foyer.

3. SÉCURITÉ

Il est possible grâce à la saisie des mouvements d’éclairer au besoin des zones difficiles à voir. Ayez toujours un œil sur ce qu’il se passe et découragez les intrus avec les capteurs et les lampes à capteur d’EGO.

4. DE L’ARGENT EN SÉCURITÉ

Les capteurs et les lampes à capteur d’EGLO vous aident à économiser de l’argent comptant. La lumière ne vient que lorsque celle-ci est requise, ce qui réduit ainsi les dépenses énergétiques de tout foyer.

OVERVIEW

SAFETY & COMFORT

Chapter / Kapitel / Chapitre Modern / Sensor



RIFORANO
38



MANFRIA
42



PALOSCO
47



FIUMICINO
50



NISIA
54



POLIENTO
55



CALDIERO
60



CALDIERO
60



ATOLLARI
62



ATOLLARI
62



CICERONE
63



PERNATE
64



RALORA 1
75



AZZINANO
75



FAVRIA 1
81



FAVRIA 1
81



TRIBANO
82



TRONO STICK
83



SESIMBA 1
92



SESIMBA 1
92



BREGANZO 1
96



BREGANZO 1
96



MUSSOTTO
96



VERRES
96



HELSINKI
58



HELSINKI
58



HELSINKI
59



FRANCARI
64



AMAROSI
66



SALVANESCO
66



RIGA 5
88



RIGA 5
88



SESIMBA 1
92



CERNO
98



CITY
98



CITY
98



OVERVIEW

SAFETY & COMFORT

Chapter / Kapitel / Chapitre **Topline / Sensor**



SAKEDA
106



BELCREDA
108



BELCREDA
108



CHEIRA
114

Chapter / Kapitel / Chapitre **Classic / Sensor**



RAVELLO
126



VERLUCCA
127



SIRMIONE
128



SIDNEY
130



LISIO
131



SOSSANO
148



MONSELICE
148



MANERBIO
148



SOSSANO
149



MONSELICE
149



MANERBIO
149



NAVEDO
150



NAVEDO
154



LATERNA 4
157



LATERNA 5
159

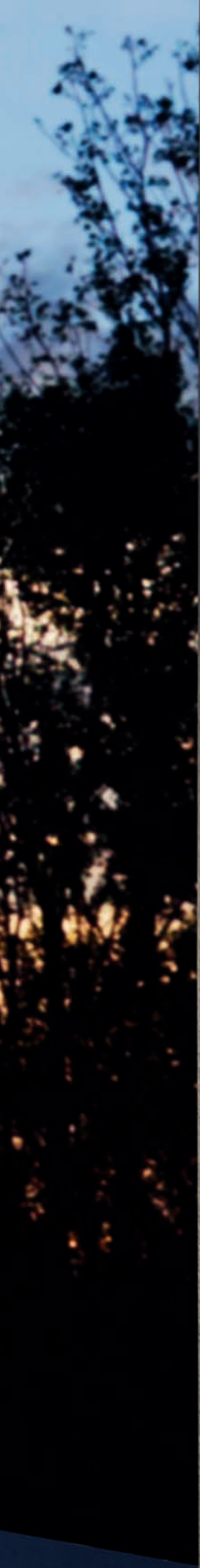

OVERVIEW

SAFETY & COMFORT

Chapter / Kapitel / Chapitre

Spots / Recessed & Accessoires / Sensor



PAGINO
164



PAGINO
164



PAGINO
164



PAGINO
164



CASABAS
164



CASABAS
164



LAMOZZO 1
166



PALIZZI
168



CASABAS
168



CASABAS
168



PASTION
168



LUNANO
170



DETECT ME 5
171



LM_LED_E27
171



DETECT ME 6
172



DETECT ME 6
172



DETECT ME 3
172



DETECT ME 3
172



DETECT ME 4
172



DETECT ME 1
173



DETECT ME 1
173



FAEDO 3
176



FAEDO 3
176



FAEDO 3
176



FAEDO 3
181



FAEDO 3
181



FAEDO 3
181



FAEDO 3
181



LAMOZZO
166



DETECT ME 5
171



DETECT ME 4
172



FAEDO 3
176



MODERN

MODERN
MODERNE

CLEAR LINES - A straight-lined and minimalist design ensures a modern touch. The luminaires made of stainless steel, aluminium or steel, combined with refined glass elements, will make your outdoor area shine in a modern and yet timeless light.

KLARE LINIEN - Geradliniges und minimalistisches Design sorgt für einen modernen Touch. Die Leuchten aus Edelstahl, Aluminium oder Stahl, kombiniert mit edlen Glaselementen, lassen Ihren Außenbereich modern und dennoch zeitlos erstrahlen.



LIGNES DISTINCTIVES - Un design minimaliste et à lignes droites assure un flair moderne. Associés à de nobles éléments en verre, les luminaires en acier, acier inoxydable ou en aluminium laissent votre extérieur rayonner d'un aspect moderne et pourtant intemporel.



OVERVIEW

MODERN



RIFORANO
38



NEMBRO
40



MANFRIA
42



DONINNI 1
44



BRIANZA
46



PALOSCO
47



MELZO
48



MELZO
49



FIUMICINO
50



DONATORI
52



PRATA VECCHIA
53



PRATA VECCHIA
53



NISIA
54



ONCALA
54



POLIENTO
55



BASALGO 1
56



HELSINKI
58



HELSINKI
59



CALDIERO
60



CALDIERO
60



ATOLLARI
62



CICERONE
63



MARCHESA
63



PERNATE
64



FRANCARI
64



CHINOA
65



PASSIRANO
65



AMAROSI
66



SALVANESCO
66



CULPINA
67



SITIA
68



MONTEROS
69



KIBEA
70



NADELA
70



ALBENZA
70



ADAMELLO
70



CORNALE
71



SONELLA
72



ARGOLIS
72



INFESTO 1
73



PIAS
74



CALGARY 1
74



TABO
74



ACATE
74



RALORA
75



RALORA 1
75



AZZINANO
75



JORBA
76



PERAFITA
77



MORINO
78



REDONDO
78



GORZANO
78



PREDAZZO
79



LAGASCO
79



CISTIerna
80



FAVRIA 1
81



TRIBANO
82



CISTIerna 1
82



DARIL 1
82



TRONO STICK
83



TRONO STICK
83



FANTECOLO
83



BEVERLY
84



STOCKHOLM 1
84



ROBLEDO
84



TONEGO
84



AGOLADA
85



RIGA-LED
86



MERLITO
86



RIGA-LED
87



RIGA 5
88



RIGA
88



RIGA
88



RIGA
89



ONTANEDA
90



ARGOLIS
90



VENTO 1
91



VENTO 2
91



PILONE
91

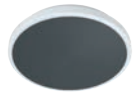

MONGODIO
91



SESIMBA
92



SESIMBA 1
92



TREVIOLo 1
94



TREVIOLo
94



BOSARO
95



PARK
96



BREGANZO
96



BREGANZO 1
96



MUSSOTTO
96



VERRES
96



CERNO
98



CITY
98



ONJA
100



LEPUS
100



SEVILLA
101



MILTON
101



ENTRIMO
101

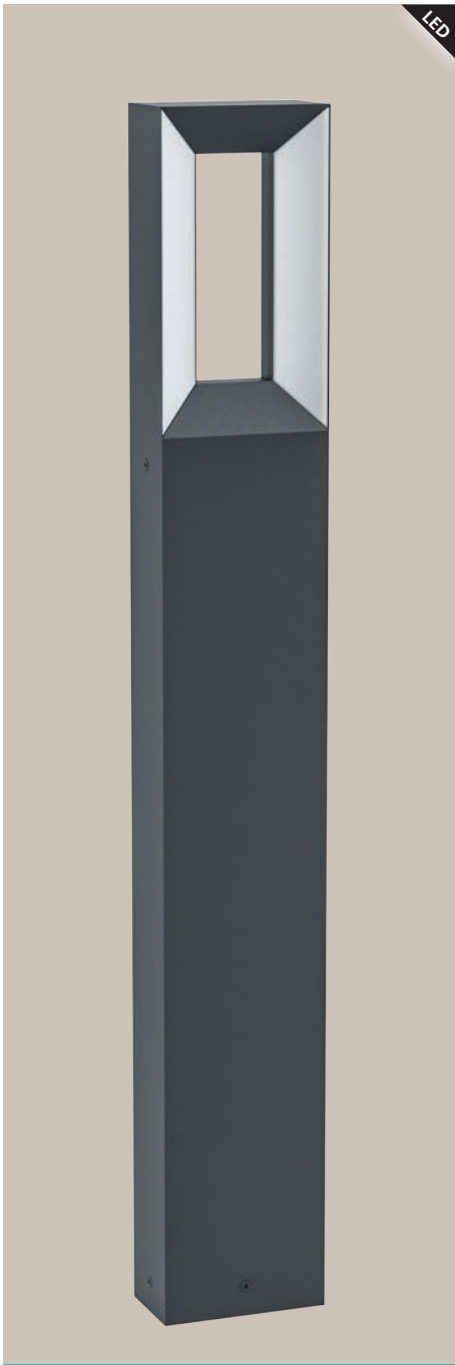

LED

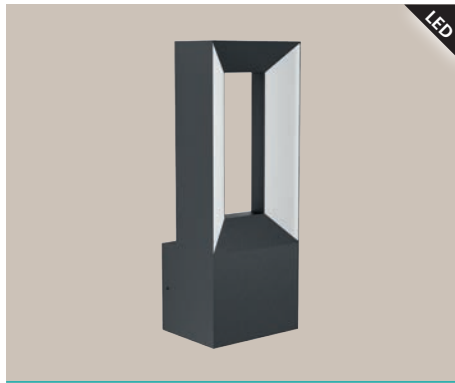

LED

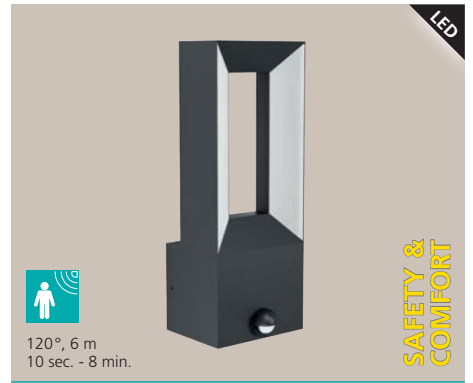

LED

SAFETY & COMFORT

98725 RIFORANO

wall light; cast aluminium, black / plastic, white
Wandleuchte; Aluguss, schwarz / Kunststoff, weiss
applique; fonte d'aluminium, noir / plastique, blanc

L 110, H 290, A 85



12W 640lm IP44



98726 RIFORANO

wall light; cast aluminium, black / plastic, white
Wandleuchte; Aluguss, schwarz / Kunststoff, weiss
applique; fonte d'aluminium, noir / plastique, blanc

L 110, H 290, A 95



12W 640lm IP44

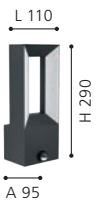

98728 RIFORANO

floor light; cast aluminium, black / plastic, white
Stehleuchte; Aluguss, schwarz / Kunststoff, weiss
lampadaire; fonte d'aluminium, noir / plastique, blanc

L 110, B 60, H 770



12W 640lm IP44



98727 RIFORANO

pedestal light; cast aluminium, black / plastic, white
Sockelleuchte; Aluguss, schwarz / Kunststoff, weiss
luminaire pour socle; fonte d'aluminium, noir / plastique, blanc

L 110, B 60, H 340



12W 640lm IP44



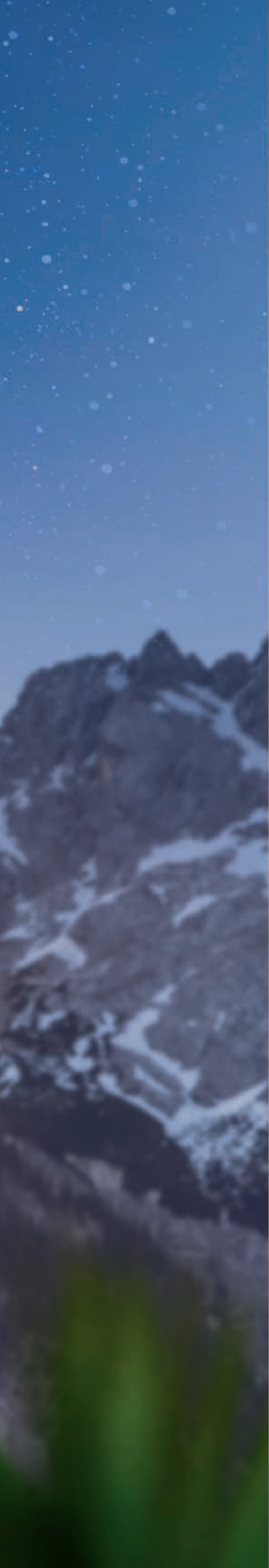

98726

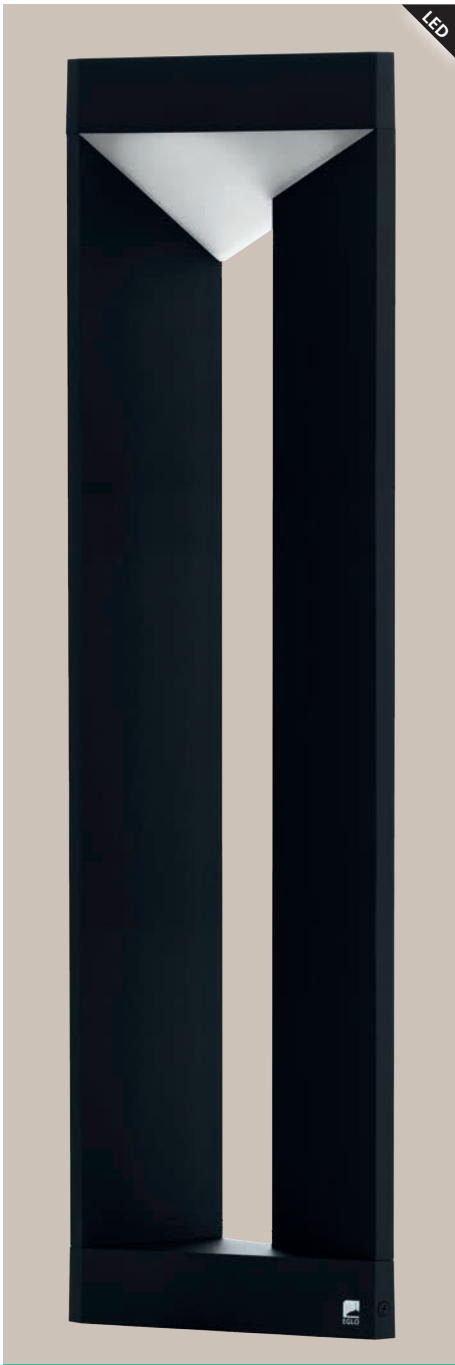

98751 NEMBRO

floor light; cast aluminium, black / plastic, white
 Stehleuchte; Aluguss, schwarz / Kunststoff, weiss
 lampadaire; fonte d'aluminium, noir / plastique, blanc

L 200, B 110, H 800



98749 NEMBRO

pedestal light; cast aluminium, black / plastic, white
 Sockelleuchte; Aluguss, schwarz / Kunststoff, weiss
 luminaire pour socle; fonte d'aluminium, noir / plastique, blanc

L 200, B 110, H 380



98748 NEMBRO

wall light; cast aluminium, black / plastic, white
 Wandleuchte; Aluguss, schwarz / Kunststoff, weiss
 applique; fonte d'aluminium, noir / plastique, blanc

L 200, H 290, A 135





98748



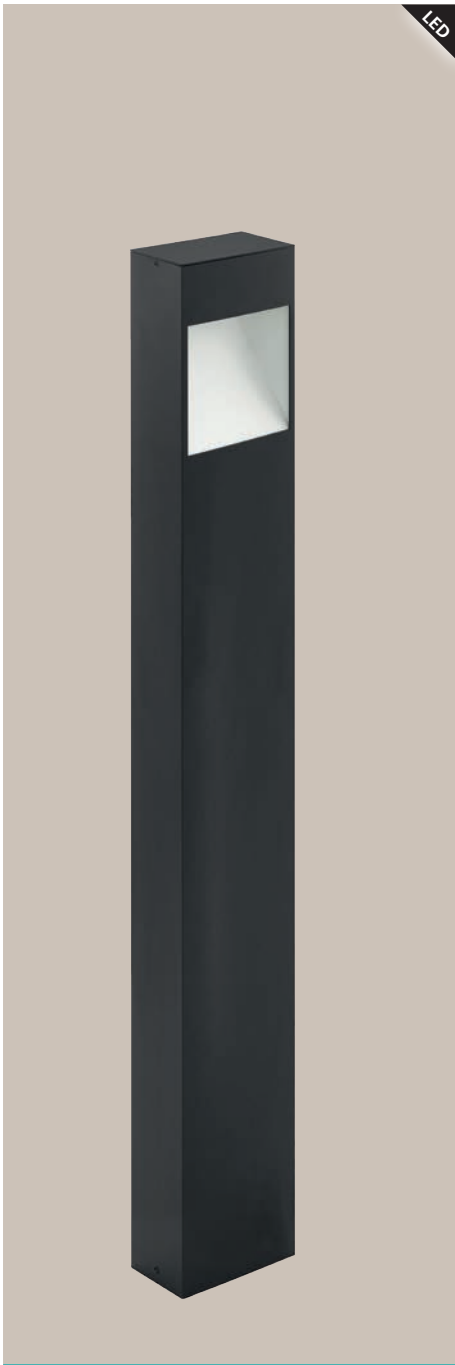

98097 MANFRIA

floor light; aluminium, anthracite, white
 Stehleuchte; Alu, anthrazit, weiss
 lampadaire; aluminium, anthracite, blanc

L 135, B 75, H 870



10W IP44



9 002759 980979



98098 MANFRIA

wall light; aluminium, anthracite, white
 Wandleuchte; Alu, anthrazit, weiss
 applique; aluminium, anthracite, blanc

L 200, H 325, A 80



10W IP44



9 002759 980986



98095 MANFRIA

wall light; aluminium, anthracite, white
 Wandleuchte; Alu, anthrazit, weiss
 applique; aluminium, anthracite, blanc

L 200, H 300, A 80



10W IP44



9 002759 980955



98096 MANFRIA

pedestal light; aluminium, anthracite, white
 Sockelleuchte; Alu, anthrazit, weiss
 luminaire pour socle; aluminium, anthracite, blanc

L 135, B 75, H 380



10W IP44



9 002759 980962





98095

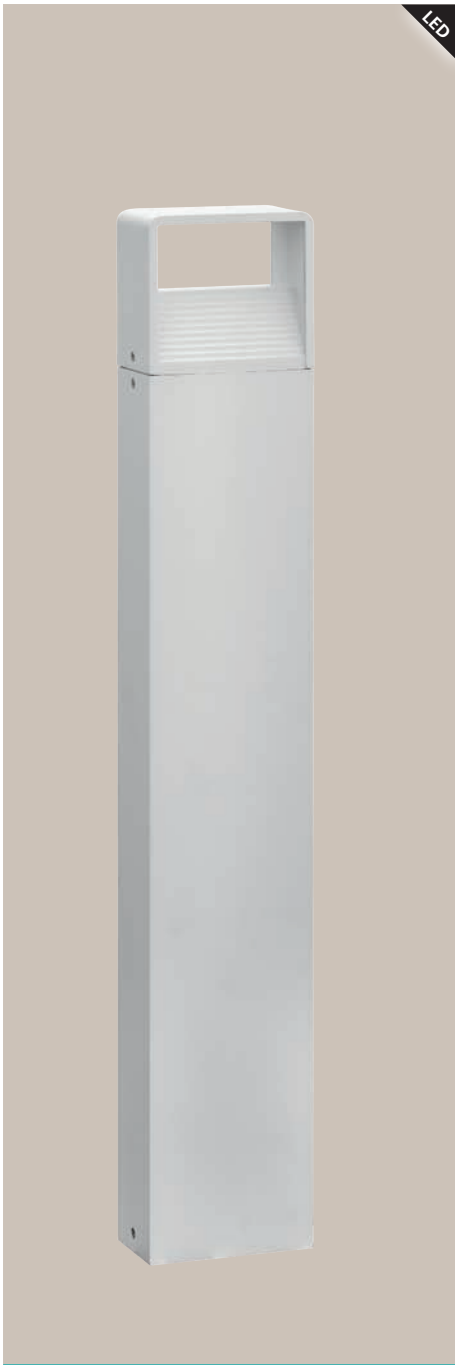

98267 DONINNI 1

pedestal light; aluminium, white / plastic, white
 Sockelleuchte; Alu, weiss / Kunststoff, weiss
 luminaire pour socle; aluminium, blanc / plastique, blanc

L 135, B 75, H 400



98266 DONINNI 1

wall light; aluminium, white / plastic, white
 Wandleuchte; Alu, weiss / Kunststoff, weiss
 applique; aluminium, blanc / plastique, blanc

L 135, B 120, H 75

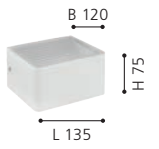

98268 DONINNI 1

floor light; aluminium, white / plastic, white
 Stehleuchte; Alu, weiss / Kunststoff, weiss
 lampadaire; aluminium, blanc / plastique, blanc

L 135, B 75, H 800



98271 DONINNI 1

pedestal light; aluminium, anthracite / plastic, white
 Sockelleuchte; Alu, anthrazit / Kunststoff, weiss
 luminaire pour socle; aluminium, anthracite / plastique, blanc

L 135, B 75, H 400



98269 DONINNI 1

wall light; aluminium, anthracite / plastic, white
 Wandleuchte; Alu, anthrazit / Kunststoff, weiss
 applique; aluminium, anthracite / plastique, blanc

L 135, B 120, H 75





98272 DONINNI 1

floor light; aluminium, anthracite / plastic, white
Stehleuchte; Alu, anthrazit / Kunststoff, weiss
lampadaire; aluminium, anthracite / plastique, blanc

L 135, B 75, H 800

LED

6W

warm
WHITE

600lm



IP44



9 002759 982720

A+

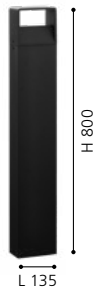

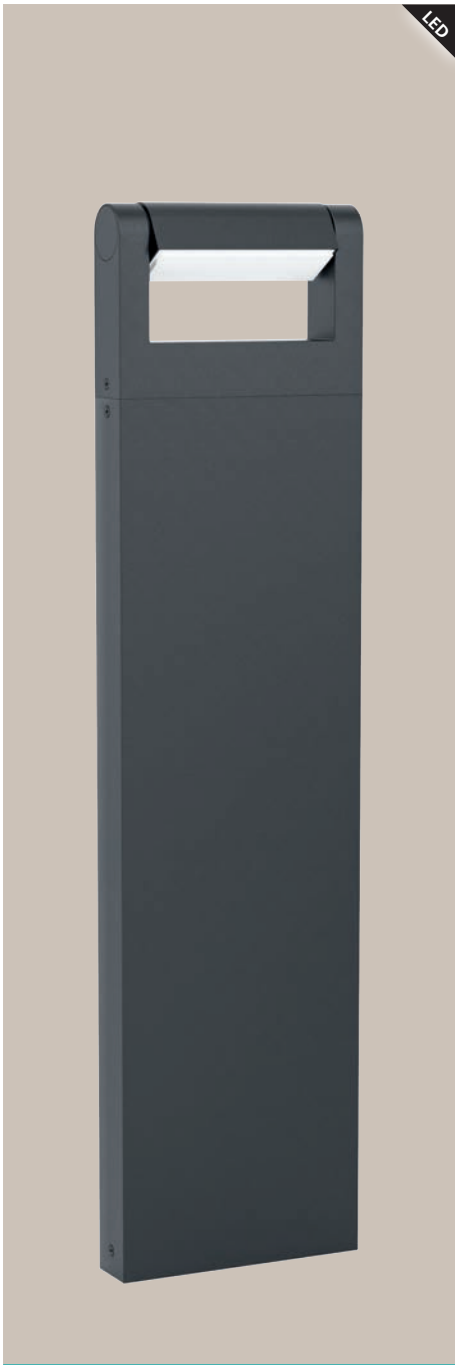

98708 BRIANZA

floor light; cast aluminium, black
 Stehleuchte; Aluguss, schwarz
 lampadaire; fonte d'aluminium, noir

L 200, B 45, H 800

- LED
4,8W
- warm
WHITE
450lm
-
- IP44



98707 BRIANZA

wall light; cast aluminium, black
 Wandleuchte; Aluguss, schwarz
 applique; fonte d'aluminium, noir

L 200, H 50, A 140

- LED
4,8W
- warm
WHITE
450lm
-
- IP44

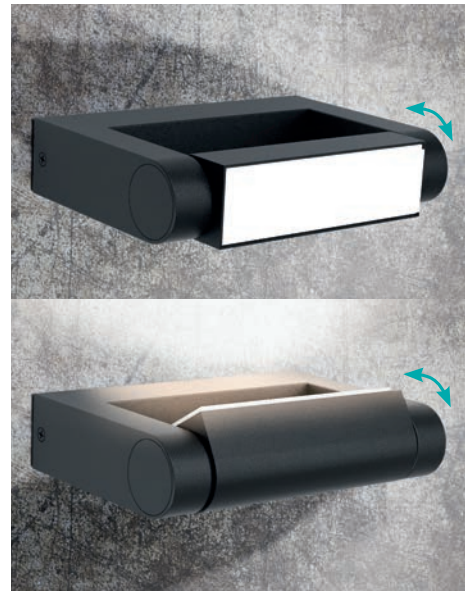
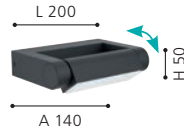

98707

The movable light head allows you to select different lighting scenes as required.

Durch den beweglichen Leuchtenkopf können Sie nach Belieben unterschiedliche Lichtszenen wählen.

La tête de luminaire mobile vous permet de sélectionner différentes scènes lumineuses en fonction de vos besoins.





98739 PALOSCO

floor light; zinc-plated steel, black / plastic, transparent
 Stehleuchte; Stahl verzinkt, schwarz / Kunststoff, transparent
 lampadaire; acier galvanisé, noir / plastique, transparent

L 140, B 220, H 820, Base: Ø 110

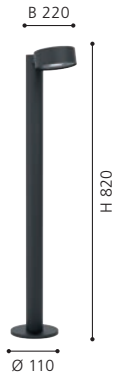

98737 PALOSCO

wall light; zinc-plated steel, black / plastic, transparent
 Wandleuchte; Stahl verzinkt, schwarz / Kunststoff, transparent
 applique; acier galvanisé, noir / plastique, transparent

L 115, H 170, A 155



98738 PALOSCO

wall light; zinc-plated steel, black / plastic, transparent
 Wandleuchte; Stahl verzinkt, schwarz / Kunststoff, transparent
 applique; acier galvanisé, noir / plastique, transparent

L 115, H 170, A 155



SAFETY &
COMFORT



90°, 6 m
10 sec. - 12 min.



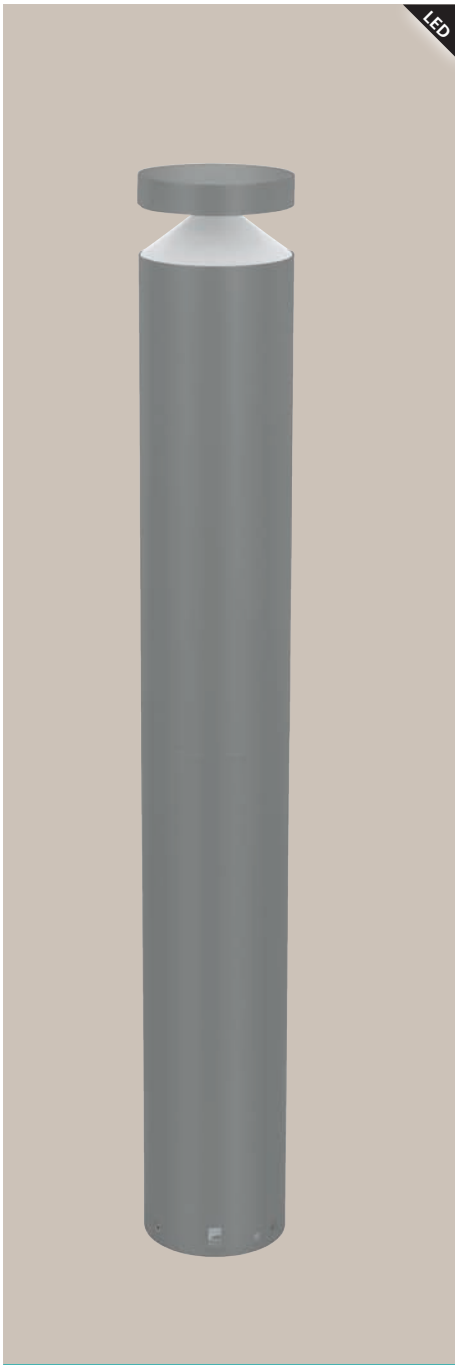

97302 MELZO

floor light; cast aluminium, silver / plastic, transparent
 Stehleuchte; Aluguss, silber / Kunststoff, transparent
 lampadaire; fonte d'aluminium, argent / plastique, transparent

H 990, Ø 135



1x 11 W 1x 950lm

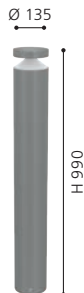

97304 MELZO

floor light; cast aluminium, black / plastic, transparent
 Stehleuchte; Aluguss, schwarz / Kunststoff, transparent
 lampadaire; fonte d'aluminium, noir / plastique, transparent

H 990, Ø 135



1x 11 W 1x 950lm



97632 MELZO

pedestal light; cast aluminium, black / plastic, transparent
 Sockelleuchte; Aluguss, schwarz / Kunststoff, transparent
 luminaire pour socle; fonte d'aluminium, noir / plastique, transparent

H 450, Ø 135



1x 11 W 1x 950lm

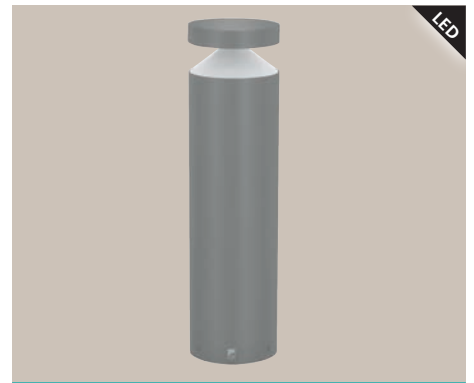

97631 MELZO

pedestal light; cast aluminium, silver / plastic, transparent
 Sockelleuchte; Aluguss, silber / Kunststoff, transparent
 luminaire pour socle; fonte d'aluminium, argent / plastique, transparent

H 450, Ø 135



1x 11 W 1x 950lm

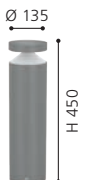

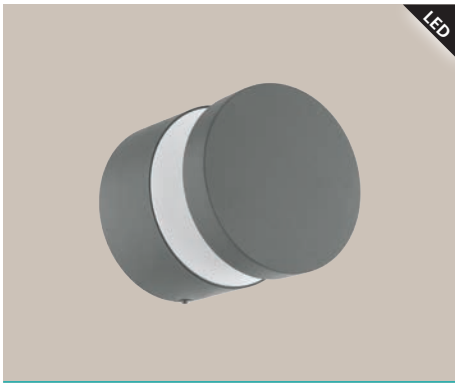

97301 MELZO

wall light; cast aluminium, silver / plastic, transparent
Wandleuchte; Aluguss, silber / Kunststoff, transparent
applique; fonte d'aluminium, argent / plastique, transparent

H 130, Ø 135



1x 11 W
1x
950lm

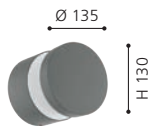

97303 MELZO

wall light; cast aluminium, black / plastic, transparent
Wandleuchte; Aluguss, schwarz / Kunststoff, transparent
applique; fonte d'aluminium, noir / plastique, transparent

H 130, Ø 135



1x 11 W
1x
950lm

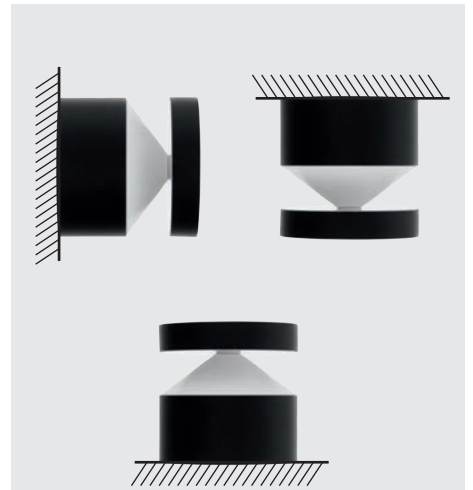

97301, 97303

These lamps have diverse uses: They can be installed on the wall or on the ceiling. The lamps variable design also permits floor placement.

Diese Leuchten sind vielseitig einsetzbar: sie können sowohl an der Wand, als auch an der Decke montiert werden. Ebenfalls ist durch das variable Design der Leuchte eine Bodenplatzierung möglich.

Ces luminaires sont d'une application multiple : ils peuvent être aussi bien montés sur le mur qu'attachés au plafond. Un placement au sol est aussi rendu possible par le design variable des luminaires.



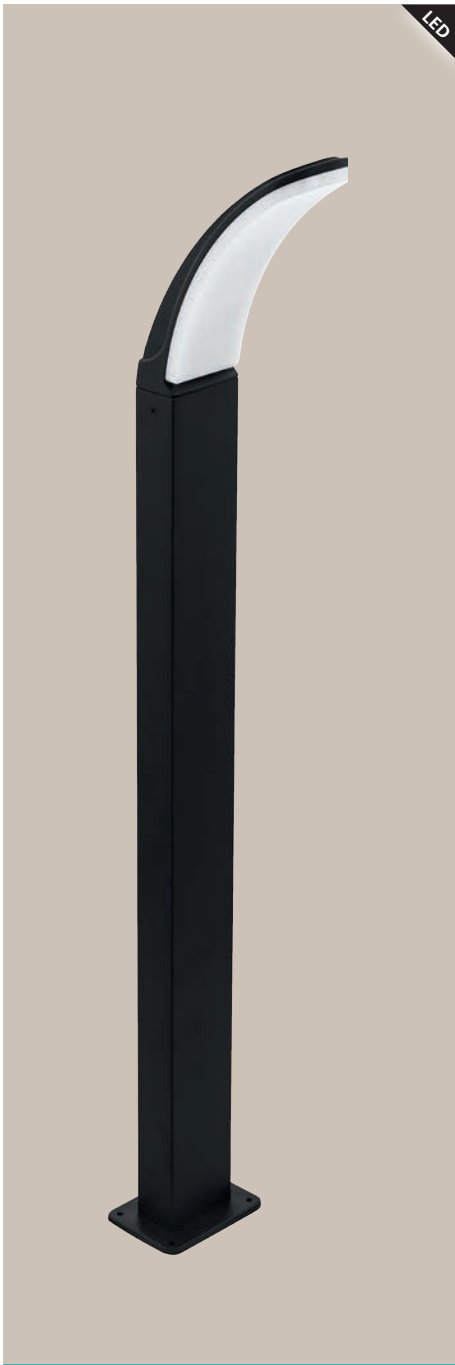

LED

98152 FIUMICINO

floor light; aluminium, black / plastic, white
 Stehleuchte; Alu, schwarz / Kunststoff, weiss
 lampadaire; aluminium, noir / plastique, blanc

H 900, Base: B 110, T 80

LED 1x 11 W
 warm WHITE 1x 1300lm
 IP44



9 002759 981525

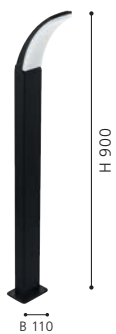

LED

98151 FIUMICINO

pedestal light; aluminium, black / plastic, white
 Sockelleuchte; Alu, schwarz / Kunststoff, weiss
 luminaire pour socle; aluminium, noir / plastique, blanc

H 450, Base: B 110, T 80

LED 1x 11 W
 warm WHITE 1x 1300lm
 IP44



9 002759 981518



LED

98148 FIUMICINO

wall light; aluminium, black / plastic, white
 Wandleuchte; Alu, schwarz / Kunststoff, weiss
 applique; aluminium, noir / plastique, blanc

L 70, H 180, A 190

LED 1x 11 W
 warm WHITE 1x 1300lm
 IP44



9 002759 981488



LED

100°, 5 m
 5 sec. - 5 min.

SAFETY & COMFORT

98149 FIUMICINO

wall light; aluminium, black / plastic, white
 Wandleuchte; Alu, schwarz / Kunststoff, weiss
 applique; aluminium, noir / plastique, blanc

L 70, H 180, A 190

LED 1x 11 W
 warm WHITE 1x 1300lm
 IP44



9 002759 981495





98148



98701 DONATORI

wall light; aluminium, plastic, black / glass, clear
Wandleuchte; Alu, Kunststoff, schwarz / Glas, klar
applique; aluminium, plastique, noir / verre, clair

L 155, H 260, A 190



9 002759 987015



98702 DONATORI

pedestal light; cast aluminium, black / glass, clear
Sockelleuchte; Aluguss, schwarz / Glas, klar
luminaire pour socle; fonte d'aluminium, noir / verre, clair

H 310, Ø 155, Base: Ø 130



9 002759 987022



98703 DONATORI

floor light; cast aluminium, black / glass, clear
Stehleuchte; Aluguss, schwarz / Glas, klar
lampadaire; fonte d'aluminium, noir / verre, clair

H 990, Ø 155, Base: Ø 130



9 002759 987039

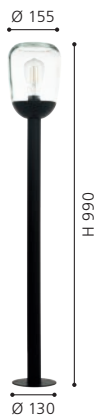

98701

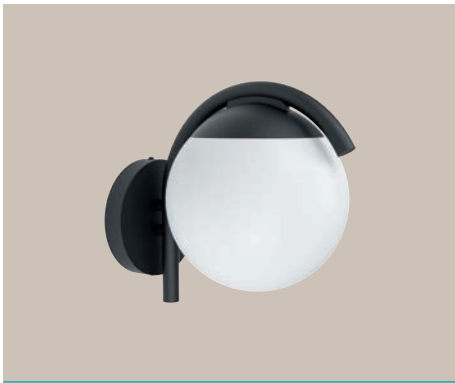

98731 PRATA VECCHIA

wall light; zinc-plated steel, black / plastic, white
Wandleuchte; Stahl verzinkt, schwarz / Kunststoff, weiss
applique; acier galvanisé, noir / plastique, blanc

L 200, H 260, A 285



98732 PRATA VECCHIA

pedestal light; zinc-plated steel, black / plastic, white
Sockelleuchte; Stahl verzinkt, schwarz / Kunststoff, weiss
luminaire pour socle; acier galvanisé, noir / plastique, blanc

L 320, B 200, H 450, Base: B 220, T 40



98733 PRATA VECCHIA

floor light; zinc-plated steel, black / plastic, white
Stehleuchte; Stahl verzinkt, schwarz / Kunststoff, weiss
lampadaire; acier galvanisé, noir / plastique, blanc

L 320, B 200, H 850, Base: B 220, T 40

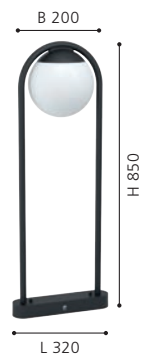

98731



GL2852



GL2852



90°, 8 m
5 sec. - 4 min.

SAFETY &
COMFORT

27126 NISIA

wall light; stainless steel, stainless steel / glass, white

Wandleuchte; Edelstahl, edelstahl / Glas, weiss

applique; acier inoxydable, acier inoxydable / verre, blanc

L 200, H 355, A 240



E27



1x 60W



IP44



9 002759 271268



GL2852

30206 NISIA

floor light; stainless steel, stainless steel / satin glass, white

Stehleuchte; Edelstahl, edelstahl / Glas satiniert, weiss

lampadaire; acier inoxydable, acier inoxydable / verre satiné, blanc

H 500, Ø 200, Base: Ø 130



E27



1x 60W



IP44



9 002759 302061



30207 NISIA

floor light; stainless steel, stainless steel / satin glass, white

Stehleuchte; Edelstahl, edelstahl / Glas satiniert, weiss

lampadaire; acier inoxydable, acier inoxydable / verre satiné, blanc

H 1000, Ø 200



E27



1x 60W



IP44

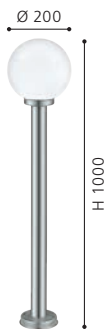

9 002759 302078



30205 NISIA

wall light; stainless steel, stainless steel / satin glass, white

Wandleuchte; Edelstahl, edelstahl / Glas satiniert, weiss

applique; acier inoxydable, acier inoxydable / verre satiné, blanc

L 200, H 360, A 240



E27



1x 60W



IP44



9 002759 302054



GL2852

LED

95982 ONCALA

wall light; stainless steel, stainless steel / satin glass, white

Wandleuchte; Edelstahl, edelstahl / Glas satiniert, weiss

applique; acier inoxydable, acier inoxydable / verre satiné, blanc

L 150, H 140, A 190



11W



950lm



IP44



9 002759 959821





90°, 7 m
10 sec. - 4 min.

**SAFETY &
COMFORT**

95017 POLIENTO

wall light; stainless steel, stainless steel /
plastic, glass, clear, white

Wandleuchte; Edelstahl, edelstahl /
Kunststoff, Glas, klar, weiss

applique; acier inoxydable, acier inoxydable /
plastique, verre, clair, blanc

L 150, H 325, A 195



E27



1x 40W



IP44



9 002759 950170



A+++ - E



95016 POLIENTO

wall light; stainless steel, stainless steel /
plastic, glass, clear, white

Wandleuchte; Edelstahl, edelstahl /
Kunststoff, Glas, klar, weiss

applique; acier inoxydable, acier inoxydable /
plastique, verre, clair, blanc

L 150, H 325, A 195



E27



1x 40W



IP44



9 002759 950163



A+++ - E



95016



94277 BASALGO 1

wall light; stainless steel, stainless steel / plastic, clear, white
 Wandleuchte; Edelstahl, edelstahl / Kunststoff, klar, weiss
 applique; acier inoxydable, acier inoxydable / plastique, clair, blanc

L 105, H 180, A 210

LED
 1x 3,7W
warm WHITE
 1x 320lm
IP44
A+



94278 BASALGO 1

floor light; stainless steel, stainless steel / plastic, clear, white
 Stehleuchte; Edelstahl, edelstahl / Kunststoff, klar, weiss
 lampadaire; acier inoxydable, acier inoxydable / plastique, clair, blanc

H 450, Ø 105

LED
 1x 3,7W
warm WHITE
 1x 320lm
IP44
A+

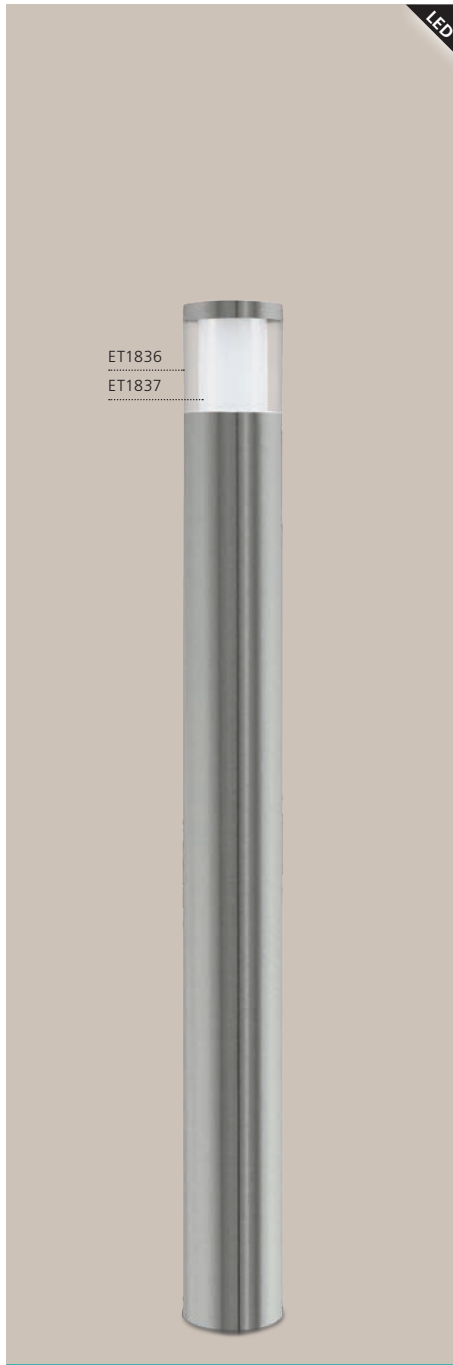

94279 BASALGO 1

floor light; stainless steel, stainless steel / plastic, clear, white
 Stehleuchte; Edelstahl, edelstahl / Kunststoff, klar, weiss
 lampadaire; acier inoxydable, acier inoxydable / plastique, clair, blanc

H 1050, Ø 105

LED
 1x 3,7W
warm WHITE
 1x 320lm
IP44
A+

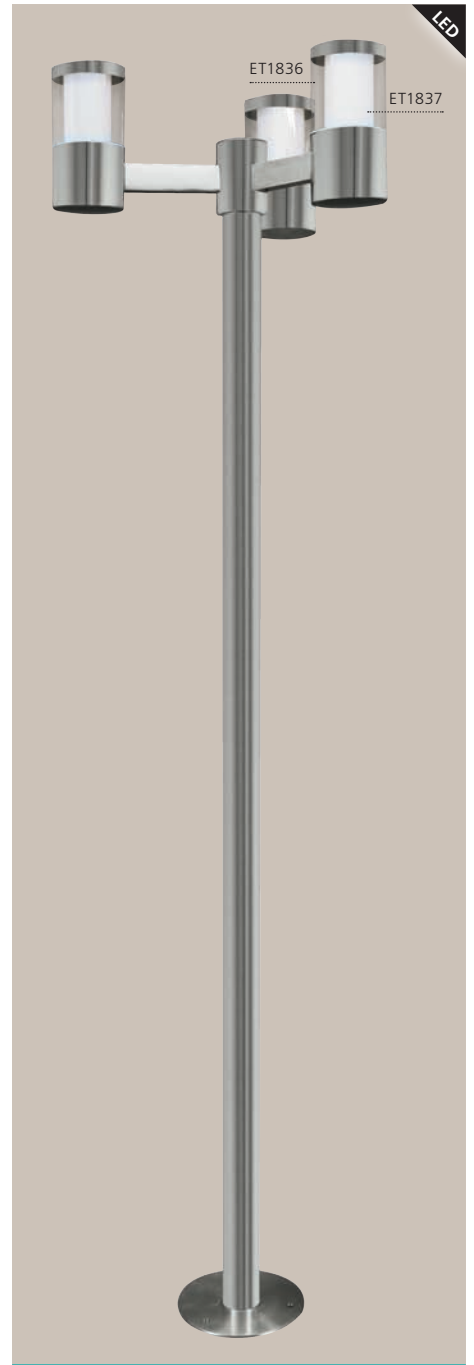

94281 BASALGO 1

floor light; stainless steel, stainless steel / plastic, clear, white
 Stehleuchte; Edelstahl, edelstahl / Kunststoff, klar, weiss
 lampadaire; acier inoxydable, acier inoxydable / plastique, clair, blanc

H 1900, Ø 490, Base: Ø 205

LED
 3x 3,7W
warm WHITE
 3x 320lm
IP44
A+



94278



94277

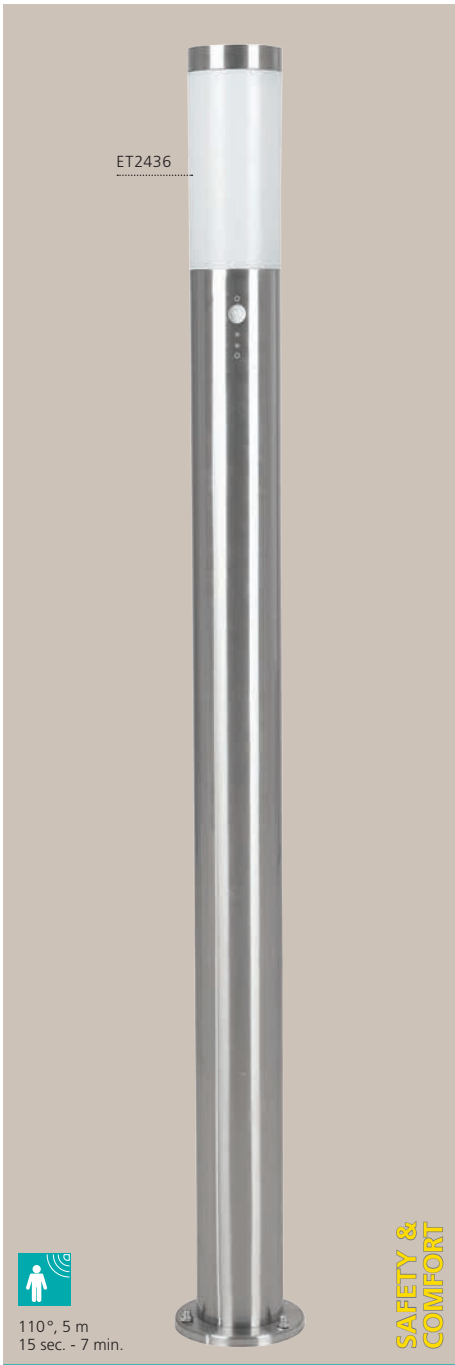

83281 HELSINKI

floor light; stainless steel, stainless steel / plastic, white
 Stehleuchte; Edelstahl, edelstahl / Kunststoff, weiss
 lampadaire; acier inoxydable, acier inoxydable / plastique, blanc

H 1100, Ø 75, Base: Ø 115

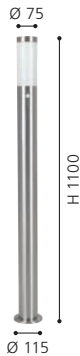

81752 HELSINKI

floor light; stainless steel, stainless steel / plastic, white
 Stehleuchte; Edelstahl, edelstahl / Kunststoff, weiss
 lampadaire; acier inoxydable, acier inoxydable / plastique, blanc

H 1100, Ø 75, Base: Ø 115



83279 HELSINKI

floor light; stainless steel, stainless steel / plastic, white
 Stehleuchte; Edelstahl, edelstahl / Kunststoff, weiss
 lampadaire; acier inoxydable, acier inoxydable / plastique, blanc

H 450, Ø 75, Base: Ø 115



81751 HELSINKI

floor light; stainless steel, stainless steel / plastic, white
 Stehleuchte; Edelstahl, edelstahl / Kunststoff, weiss
 lampadaire; acier inoxydable, acier inoxydable / plastique, blanc

H 450, Ø 75, Base: Ø 115

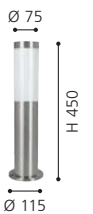

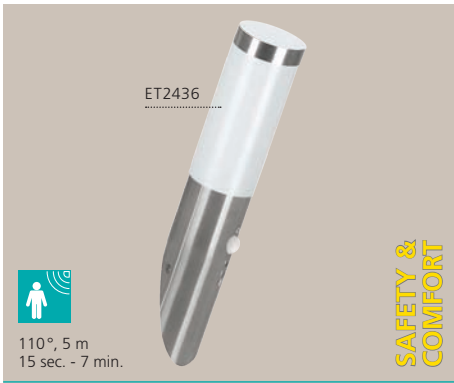

ET2436



110°, 5 m
15 sec. - 7 min.

**SAFETY &
COMFORT**

83278 HELSINKI

wall light; stainless steel, stainless steel / plastic, white
Wandleuchte; Edelstahl, edelstahl / Kunststoff, weiss
applique; acier inoxydable, acier inoxydable / plastique, blanc

H 425, Ø 75, A 165



E27



1x 12W



IP44



9 002759 832780



A++-B

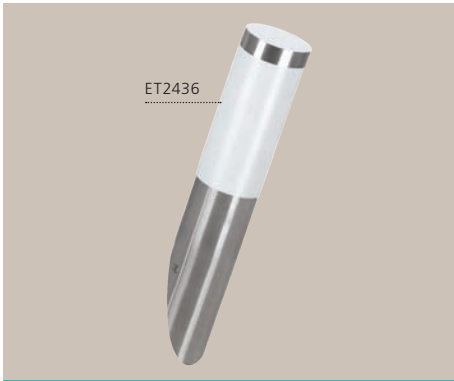

ET2436

81753 HELSINKI

wall light; stainless steel, stainless steel / plastic, white
Wandleuchte; Edelstahl, edelstahl / Kunststoff, weiss
applique; acier inoxydable, acier inoxydable / plastique, blanc

H 390, Ø 75, A 165



E27



1x 12W



IP44



9 002759 817534



A++-B

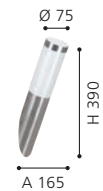

81751



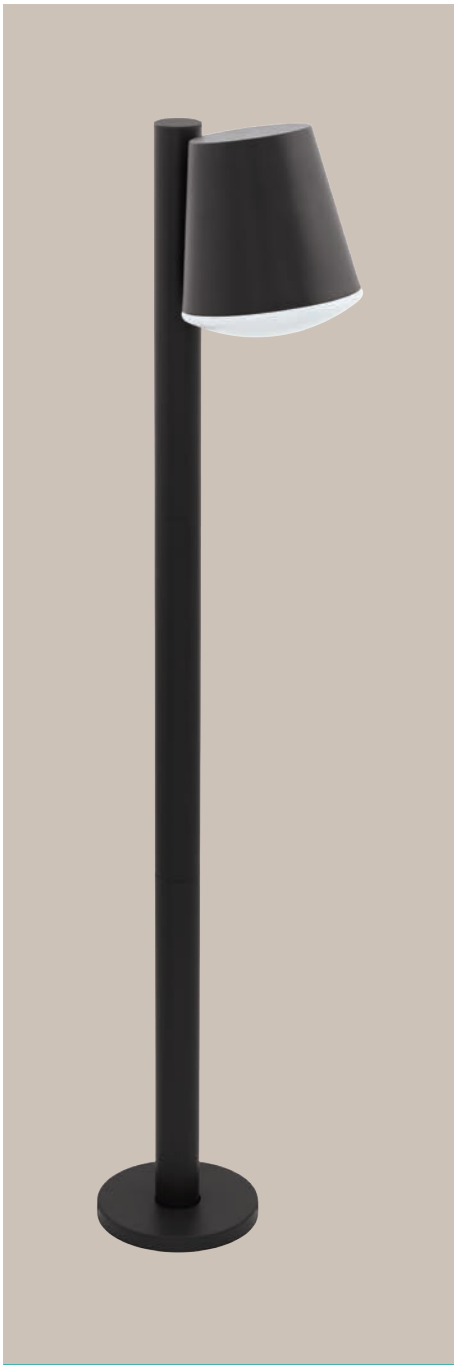

97147 CALDIERO

floor light; zinc-plated steel, anthracite / plastic, white
 Stehleuchte; Stahl verzinkt, anthrazit / Kunststoff, weiss
 lampadaire; acier galvanisé, anthracite / plastique, blanc

L 240, B 140, H 965, Base: Ø 140

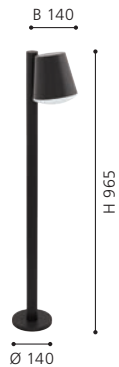

97451 CALDIERO

wall light; zinc-plated steel, anthracite / plastic, white
 Wandleuchte; Stahl verzinkt, anthrazit / Kunststoff, weiss
 applique; acier galvanisé, anthracite / plastique, blanc

L 140, H 240, A 185



97453 CALDIERO

wall light; stainless steel, stainless steel / plastic, white
 Wandleuchte; Edelstahl, edelstahl / Kunststoff, weiss
 applique; acier inoxydable, acier inoxydable / plastique, blanc

L 140, H 240, A 185



97146 CALDIERO

wall light; zinc-plated steel, anthracite / plastic, white
 Wandleuchte; Stahl verzinkt, anthrazit / Kunststoff, weiss
 applique; acier galvanisé, anthracite / plastique, blanc

L 140, H 240, A 185





97451

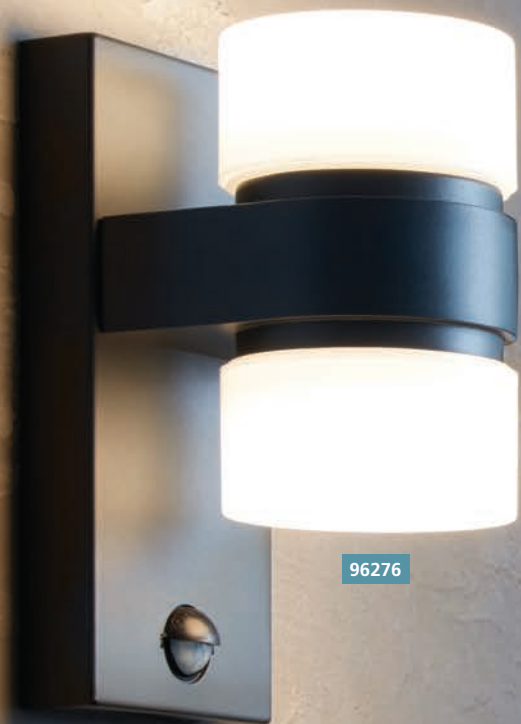

96276



96276 ATOLLARI

wall light; cast aluminium, anthracite / plastic, white
 Wandleuchte; Aluguss, anthrazit / Kunststoff, weiss
 applique; fonte d'aluminium, anthracite / plastique, blanc

L 100, H 230, A 155

LED
 warm WHITE
 2x 6W 2x 500lm

IP44



A+



96277 ATOLLARI

wall light; cast aluminium, stainless steel, silver / plastic, white
 Wandleuchte; Aluguss, edelstahl, silber / Kunststoff, weiss
 applique; fonte d'aluminium, acier inoxydable, argent / plastique, blanc

L 100, H 230, A 155

LED
 warm WHITE
 2x 6W 2x 500lm

IP44



A+





LED

98147 MARCHESA

wall light; stainless steel, stainless steel / plastic, white
Wandleuchte; Edelstahl, edelstahl / Kunststoff, weiss
applique; acier inoxydable, acier inoxydable / plastique, blanc

H 70, Ø 300



9 002759 981471



Ø 300



LED



90°, 8 m
5 sec. - 5 min.

SAFETY &
COMFORT

98128 CICERONE

wall light; stainless steel, plastic, stainless steel, silver / plastic, white
Wandleuchte; Edelstahl, Kunststoff, edelstahl, silber / Kunststoff, weiss
applique; acier inoxydable, plastique, acier inoxydable, argent / plastique, blanc
L 200, H 315, A 175



9 002759 981280



LED

98127 CICERONE

wall light; stainless steel, plastic, stainless steel, silver / plastic, white
Wandleuchte; Edelstahl, Kunststoff, edelstahl, silber / Kunststoff, weiss
applique; acier inoxydable, plastique, acier inoxydable, argent / plastique, blanc
L 200, H 315, A 175



9 002759 981273



98128



98233 FRANCARI

wall light; cast aluminium, anthracite / plastic, white
 Wandleuchte; Aluguss, anthrazit / Kunststoff, weiss
 applique; fonte d'aluminium, anthracite / plastique, blanc

L 220, H 275, A 225

1x 11 W
 1x 1000lm
 IP44



98232 FRANCARI

wall light; cast aluminium, anthracite / plastic, white
 Wandleuchte; Aluguss, anthrazit / Kunststoff, weiss
 applique; fonte d'aluminium, anthracite / plastique, blanc

L 220, H 255, A 225

1x 11 W
 1x 1000lm
 IP44



97307 PERNATE

wall light; cast aluminium, anthracite / plastic, white
 Wandleuchte; Aluguss, anthrazit / Kunststoff, weiss
 applique; fonte d'aluminium, anthracite / plastique, blanc

L 250, H 235, A 170

11 W
 1250lm
 IP44



98233



97308 PERNATE

wall light; cast aluminium, anthracite / plastic, white
 Wandleuchte; Aluguss, anthrazit / Kunststoff, weiss
 applique; fonte d'aluminium, anthracite / plastique, blanc

L 250, H 235, A 170

11 W
 1250lm
 IP44



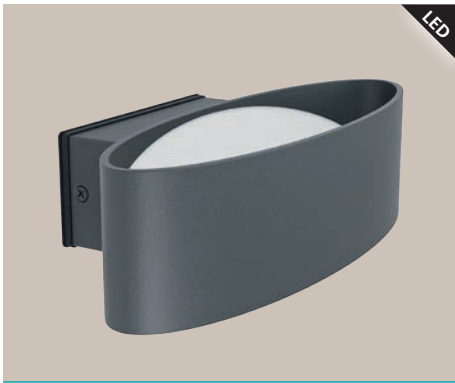

98711 CHINOA

wall light; aluminium, steel, anthracite / plastic, transparent
Wandleuchte; Alu, Stahl, anthrazit / Kunststoff, transparent
applique; aluminium, acier, anthracite / plastique, transparent

L 270, H 75, A 135



10W 1100lm



98709 CHINOA

wall light; aluminium, steel, white / plastic, transparent
Wandleuchte; Alu, Stahl, weiss / Kunststoff, transparent
applique; aluminium, acier, blanc / plastique, transparent

L 270, H 75, A 135



10W 1100lm



98729 PASSIRANO

wall light; cast aluminium, black, white / plastic, transparent
Wandleuchte; Aluguss, schwarz, weiss / Kunststoff, transparent
applique; fonte d'aluminium, noir, blanc / plastique, transparent

L 240, H 120, A 110



4,8W 500lm





98704 SALVANESCO

wall light; cast aluminium, black / plastic, white
Wandleuchte; Aluguss, schwarz / Kunststoff, weiss
applique; fonte d'aluminium, noir / plastique, blanc

L 180, H 240, A 90

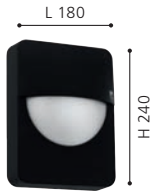

98091 AMAROSI

wall light; aluminium, black / plastic, white
Wandleuchte; Alu, schwarz / Kunststoff, weiss
applique; aluminium, noir / plastique, blanc

L 170, H 210, A 205



98092 AMAROSI

wall light; aluminium, black / plastic, white
Wandleuchte; Alu, schwarz / Kunststoff, weiss
applique; aluminium, noir / plastique, blanc

L 170, H 210, A 205



SAFETY & COMFORT

90°, 8 m
5 sec. - 5 min.



98705 SALVANESCO

wall light; cast aluminium, black / plastic, white
Wandleuchte; Aluguss, schwarz / Kunststoff, weiss
applique; fonte d'aluminium, noir / plastique, blanc

L 180, H 240, A 90



1x
A-F

3x
0-9

98091, 98092

Letters and numbers included in delivery.

Buchstaben und Zahlen im Lieferumfang enthalten.

Les lettres et les nombres sont inclus dans la livraison.



LED

98088 CULPINA

wall light; aluminium, anthracite / plastic, white
 Wandleuchte; Alu, anthrazit / Kunststoff, weiss
 applique; aluminium, anthracite / plastique, blanc

L 190, H 270, A 80



1x 10W



1x
830lm



IP44



9 002759 980887



A+



LED

98087 CULPINA

wall light; aluminium, white / plastic, white
 Wandleuchte; Alu, weiss / Kunststoff, weiss
 applique; aluminium, blanc / plastique, blanc

L 190, H 270, A 80



1x 10W



1x
830lm



IP44



9 002759 980870



A+



98088



95987



95988 SITIA

wall light; zinc-plated steel, anthracite / plastic, white
Wandleuchte; Stahl verzinkt, anthrazit / Kunststoff, weiss
applique; acier galvanisé, anthracite / plastique, blanc

L 180, H 180, A 55

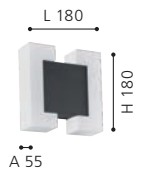

95987 SITIA

wall light; zinc-plated steel, satin nickel / plastic, white
Wandleuchte; Stahl verzinkt, nickel-matt / Kunststoff, weiss
applique; acier galvanisé, nickel mat / plastique, blanc

L 180, H 180, A 55

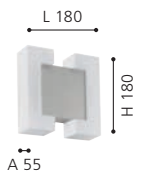



98144 MONTEROS

wall light; aluminium, anthracite / glass, plastic, clear, white
 Wandleuchte; Alu, anthrazit / Glas, Kunststoff, klar, weiss
 applique; aluminium, anthracite / verre, plastique, clair, blanc

L 250, H 335, A 95



E27 1x 28W IP44



9 002759 981440



A+++



98143 MONTEROS

wall light; aluminium, white / glass, plastic, clear, white
 Wandleuchte; Alu, weiss / Glas, Kunststoff, klar, weiss
 applique; aluminium, blanc / verre, plastique, clair, blanc

L 250, H 335, A 95



E27 1x 28W IP44

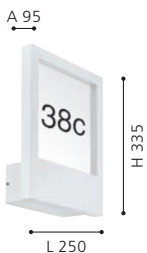

9 002759 981433



A+++



98144



1x A-F 3x 0-9

98144, 98143

Letters and numbers included in delivery.

Buchstaben und Zahlen im Lieferumfang enthalten.

Les lettres et les nombres sont inclus dans la livraison.





93254 KIBE A

wall light; zinc-plated steel, white, anthracite
Wandleuchte; Stahl verzinkt, weiss, anthrazit
applique; acier galvanisé, blanc, anthracite

L 150, H 260, A 75

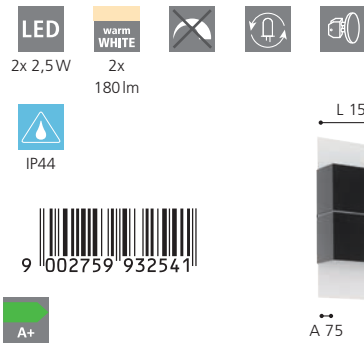

93438 NADELA

wall light; stainless steel, stainless steel / satin glass, white
Wandleuchte; Edelstahl, edelstahl / Glas satiniert, weiss
applique; acier inoxydable, acier inoxydable / verre satiné, blanc

L 215, H 290, A 90

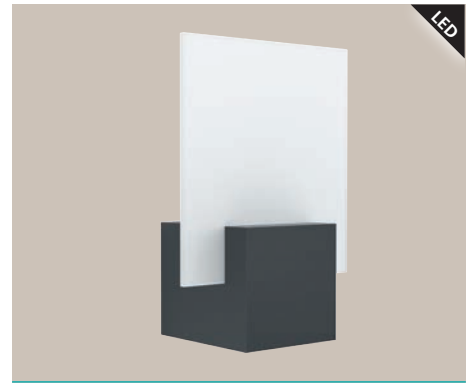
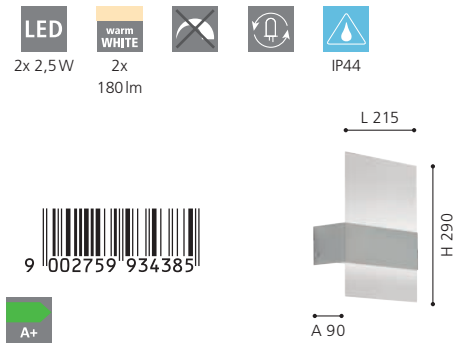

98745 ADAMELLO

wall light; cast aluminium, black / satin glass, white
Wandleuchte; Aluguss, schwarz / Glas satiniert, weiss
applique; fonte d'aluminium, noir / verre satiné, blanc

L 200, H 280, A 130

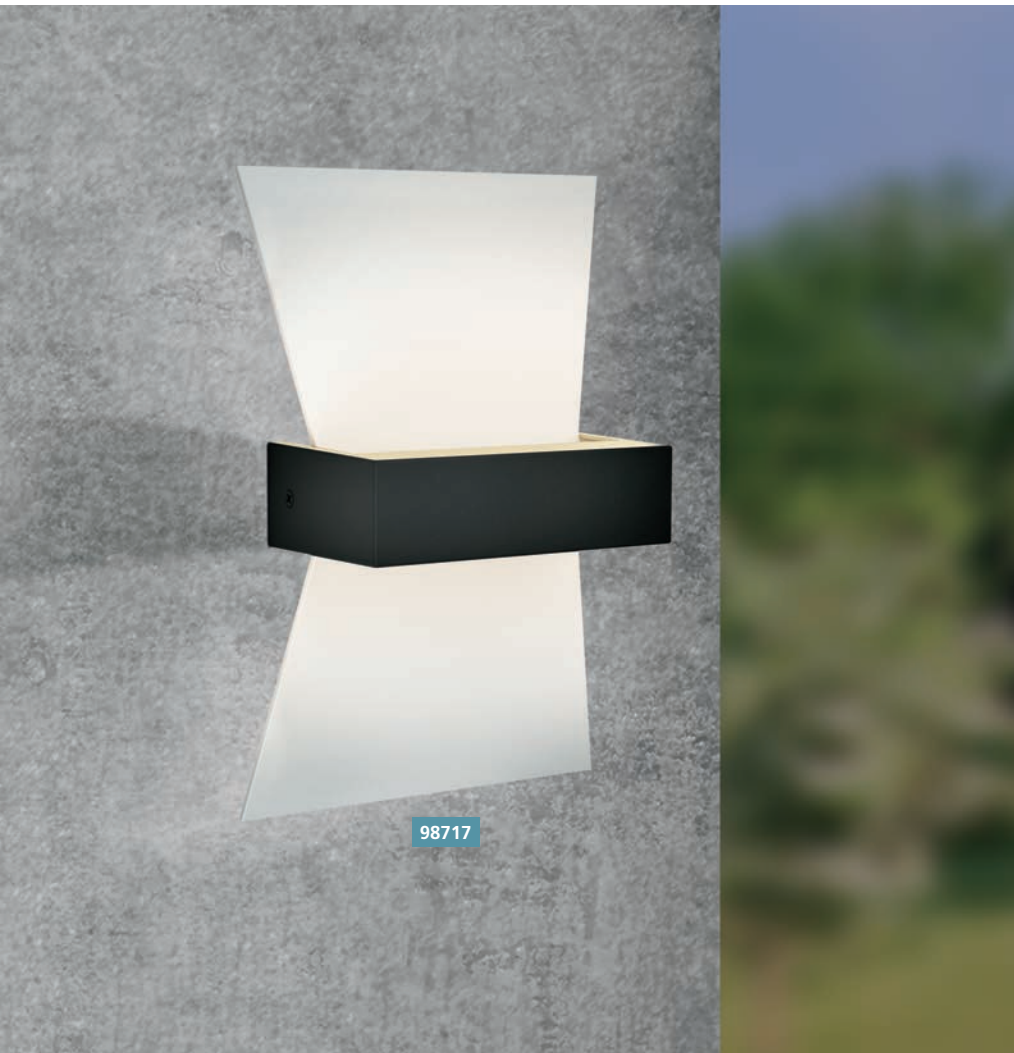
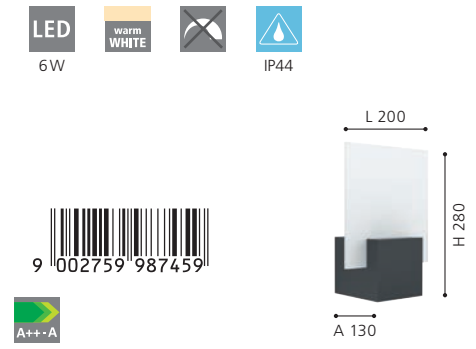

98717



98717 ALBENZA

wall light; cast aluminium, white, anthracite
Wandleuchte; Aluguss, weiss, anthrazit
applique; fonte d'aluminium, blanc, anthracite

L 200, H 300, A 95

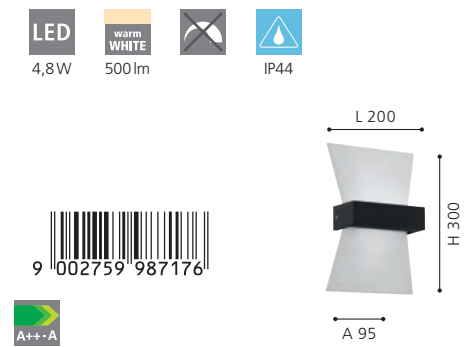



97289 CORNALE

wall / ceiling light; plastic, anthracite / plastic, white
 Wand- / Deckenleuchte; Kunststoff, anthrazit / Kunststoff, weiss
 applique / plafonnier; plastique, anthracite / plastique, blanc

L 215, H 215, A 70

LED
 1x 8,2W
 warm WHITE
 1x 820lm
 IP44



97289

Automatic illumination. This photoelectric lighting controller is used for controlling lighting systems for building fronts and automatically switches light 'ON' at dusk automatically 'OFF' again at dawn. Of course, the light-level threshold at which the sensor responds and turns the light 'ON' is defined by no other than you yourself.

Automatische Beleuchtung. Der Day & Night Sensor dient zur Steuerung von Beleuchtungsanlagen an Hausfronten und schaltet bei Dämmerung automatisch Licht AN und am Morgen automatisch wieder AUS. Die Dämmerungsschwelle, bei der der Sensor reagiert und die Beleuchtung schaltet, definieren Sie natürlich selbst.

Un éclairage automatique. Le Interrupteur crépusculaire pour la commande des installations d'éclairage pour les façades de maison e il allume automatiquement la lumière au crépuscule et l'éteint automatiquement à l'aube. C'est naturellement à vous de définir le seuil de luminosité auquel doit réagir le détecteur et allumer la lumière.



1x A-F 3x 0-9

97289

Letters and numbers included in delivery.

Buchstaben und Zahlen im Lieferumfang enthalten.

Les lettres et les nombres sont inclus dans la livraison.





94871 SONELLA

wall / ceiling light; plastic, white / plastic, white

Wand- / Deckenleuchte; Kunststoff, weiss / Kunststoff, weiss

applique / plafonnier; plastique, blanc / plastique, blanc

L 215, H 215, A 70



8,2W 820lm



94872 SONELLA

wall / ceiling light; plastic, anthracite / plastic, white

Wand- / Deckenleuchte; Kunststoff, anthrazit / Kunststoff, weiss

applique / plafonnier; plastique, anthracite / plastique, blanc

L 215, H 215, A 70



8,2W 820lm



96494 ARGOLIS

wall / ceiling light; cast aluminium, white / plastic, white

Wand- / Deckenleuchte; Aluguss, weiss / Kunststoff, weiss

applique / plafonnier; fonte d'aluminium, blanc / plastique, blanc

L 300, B 300, H 40



22W 2600lm

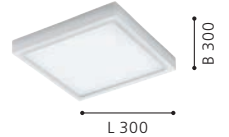
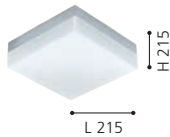

96495 ARGOLIS

wall / ceiling light; cast aluminium, anthracite / plastic, white

Wand- / Deckenleuchte; Aluguss, anthrazit / Kunststoff, weiss

applique / plafonnier; fonte d'aluminium, anthracite / plastique, blanc

L 300, B 300, H 40



22W 2600lm

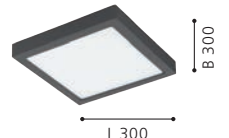



ET2173

94877 INFESTO 1

wall / ceiling light; stainless steel, plastic, stainless steel, silver / plastic, white

Wand- / Deckenleuchte; Edelstahl, Kunststoff, edelstahl, silber / Kunststoff, weiss

applique / plafonnier; acier inoxydable, plastique, acier inoxydable, argent / plastique, blanc

L 250, H 250, A 70

LED

8,2W

warm
WHITE

820lm



IP44



9 002759 948771

A+

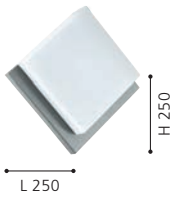

H 250

L 250



94877

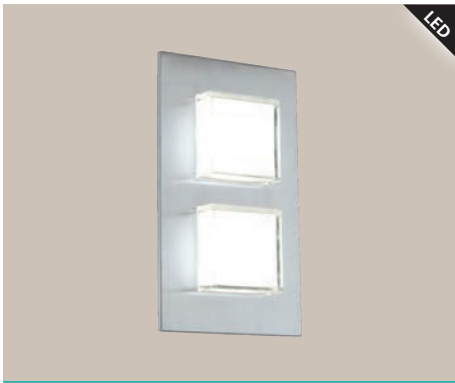

LED

93365 PIAS

wall light; stainless steel, stainless steel
Wandleuchte; Edelstahl, edelstahl
applique; acier inoxydable, acier inoxydable

L 150, H 250, A 55



LED

ET2168

94845 ACATE

wall / ceiling light; aluminium, steel, silver / plastic, white
Wand- / Deckenleuchte; Alu, Stahl, silber / Kunststoff, weiss
applique / plafonnier; aluminium, acier, argent / plastique, blanc

L 100, H 350, A 60



LED

94186 TABO

wall light; aluminium, silver
Wandleuchte; Alu, silber
applique; aluminium, argent

L 75, B 75, H 195, A 105



94114



LED

ET1811

94114 CALGARY 1

wall light; stainless steel, stainless steel / plastic, white
Wandleuchte; Edelstahl, edelstahl / Kunststoff, weiss
applique; acier inoxydable, acier inoxydable / plastique, blanc

L 200, H 200, A 95

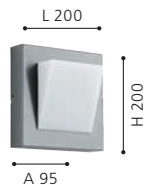



 100°, 6 m
 10 sec. - 5 min.

**SAFETY &
COMFORT**

95989 RALORA 1

wall light; stainless steel, stainless steel / plastic, white
 Wandleuchte; Edelstahl, edelstahl / Kunststoff, weiss
 applique; acier inoxydable, acier inoxydable / plastique, blanc

L 170, H 290, A 100



12W 1000lm



IP44



9 002759 959890



A+



 120°, 6 m
 10 sec. - 8 min.

**SAFETY &
COMFORT**

94086 RALORA

wall light; stainless steel, stainless steel / plastic, white
 Wandleuchte; Edelstahl, edelstahl / Kunststoff, weiss
 applique; acier inoxydable, acier inoxydable / plastique, blanc

L 140, H 240, A 70



3x 2,5W 3x 180lm



IP44



9 002759 940867



A+



 120°, 6 m
 10 sec. - 8 min.

**SAFETY &
COMFORT**

97159 AZZINANO

wall light; zinc-plated steel, silver / plastic, white
 Wandleuchte; Stahl verzinkt, silber / Kunststoff, weiss
 applique; acier galvanisé, argent / plastique, blanc

L 185, H 115, A 125



2x 5,6W



IP44



9 002759 971595



A++

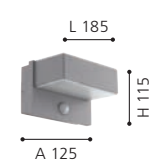

97159



96255



96256 JORBA

wall light; cast aluminium, anthracite / plastic, white
Wandleuchte; Aluguss, anthrazit / Kunststoff, weiss
applique; fonte d'aluminium, anthracite / plastique, blanc

L 110, H 110, A 110



1x 6W



1x
500lm



IP44



9 002759 962562

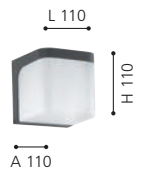

A+



96255 JORBA

wall light; cast aluminium, white / plastic, white
Wandleuchte; Aluguss, weiss / Kunststoff, weiss
applique; fonte d'aluminium, blanc / plastique, blanc

L 110, H 110, A 110



1x 6W



1x
500lm



IP44



9 002759 962555

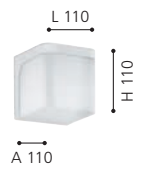

A+



96007



96007 PERAFITA

wall light; cast aluminium, anthracite / plastic, white
Wandleuchte; Aluguss, anthrazit / Kunststoff, weiss
applique; fonte d'aluminium, anthracite / plastique, blanc

L 175, H 170, A 95

LED

2x 6W

warm
WHITE

2x
500lm



IP44



9 002759 960070

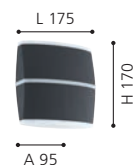

A+



96006 PERAFITA

wall light; cast aluminium, white / plastic, white
Wandleuchte; Aluguss, weiss / Kunststoff, weiss
applique; fonte d'aluminium, blanc / plastique, blanc

L 175, H 170, A 95

LED

2x 6W

warm
WHITE

2x
500lm



IP44



9 002759 960063



A+



LED

93368 REDONDO

wall light; cast aluminium, anthracite
Wandleuchte; Aluguss, anthrazit
applique; fonte d'aluminium, anthracite

L 160, H 175, A 125



2x 2,5W 2x 180lm



IP44



9 002759 933685



A+



LED

93319 MORINO

wall light; cast aluminium, anthracite
Wandleuchte; Aluguss, anthrazit
applique; fonte d'aluminium, anthracite

L 140, H 180, A 105



2x 2,5W 2x 180lm



IP44



9 002759 933197

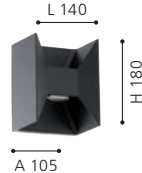

A+



LED

93318 MORINO

wall light; cast aluminium, white
Wandleuchte; Aluguss, weiss
applique; fonte d'aluminium, blanc

L 140, H 180, A 105



2x 2,5W 2x 180lm



IP44



9 002759 933180

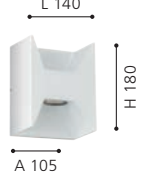

A+



LED

97222 GORZANO

wall light; zinc-plated steel, anthracite / plastic, satined
Wandleuchte; Stahl verzinkt, anthrazit / Kunststoff, satiniert
applique; acier galvanisé, anthracite / plastique, satiné

L 80, H 290, A 105



1x 4,8W 500lm



A+



9 002759 972226

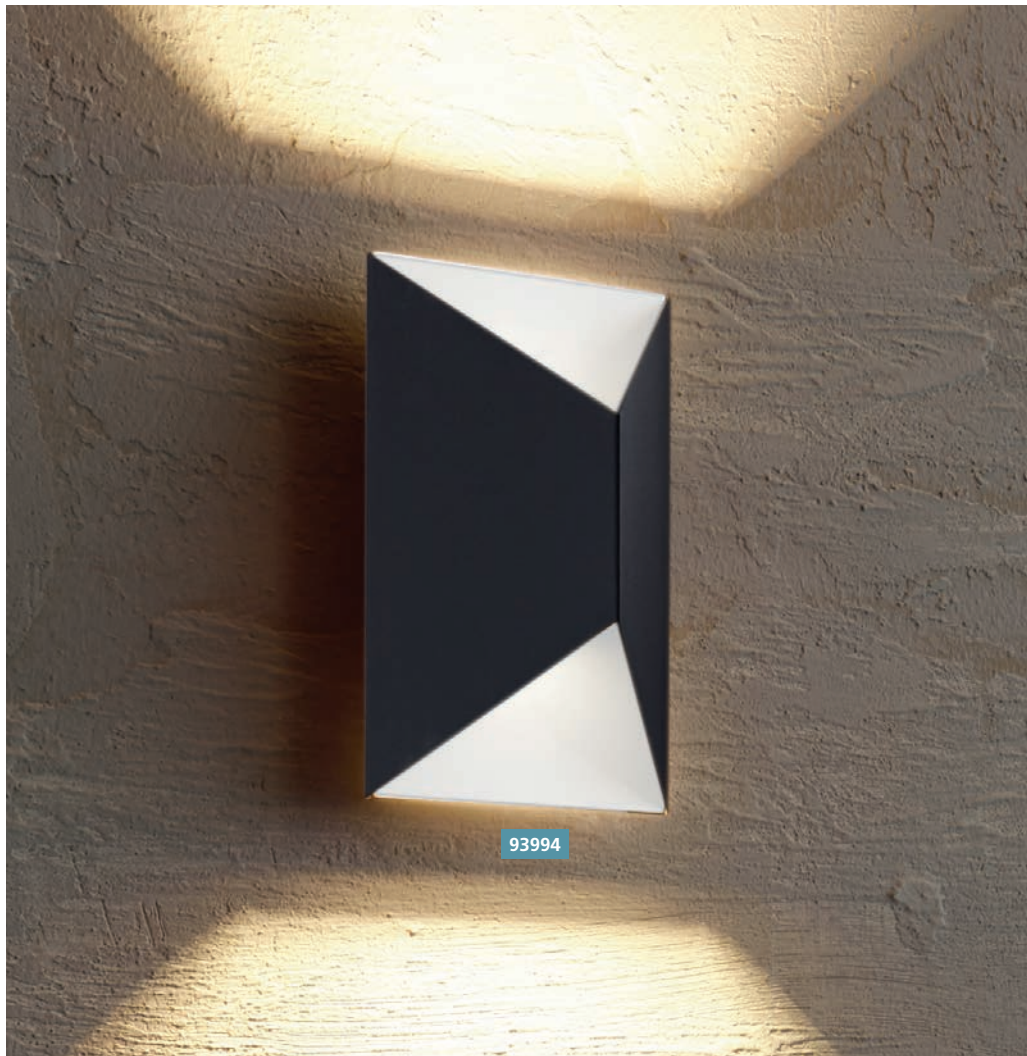

93994

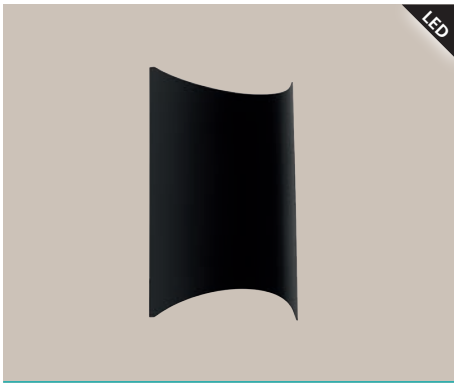

LED

98736 LAGASCO

wall / ceiling light; zinc-plated steel, black
Wand- / Deckenleuchte; Stahl verzinkt, schwarz
applique / plafonnier; acier galvanisé, noir

L 185, H 275, A 85



10W



IP44



9 002759 987367



A+

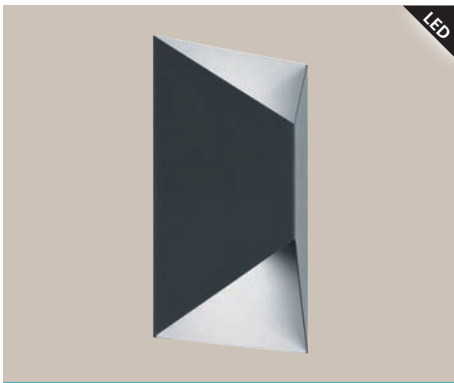
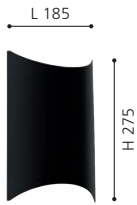

LED

93994 PREDAZZO

wall light; zinc-plated steel, anthracite, white
Wandleuchte; Stahl verzinkt, anthrazit, weiss
applique; acier galvanisé, anthracite, blanc

L 140, H 210, A 75



2x 2,5W



2x 180lm



IP44



9 002759 939946



A+

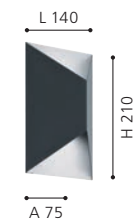

98736



98086 CISTIerna

wall light; zinc-plated steel, anthracite / plastic, white
Wandleuchte; Stahl verzinkt, anthrazit / Kunststoff, weiss
applique; acier galvanisé, anthracite / plastique, blanc

L 180, H 350, A 90



E27



2x 10W



IP44



9 002759 980863



A++-B



L 180

H 350



98085 CISTIerna

wall light; stainless steel, stainless steel / plastic, white
Wandleuchte; Edelstahl, edelstahl / Kunststoff, weiss
applique; acier inoxydable, acier inoxydable / plastique, blanc

L 180, H 350, A 90



E27



2x 10W



IP44



9 002759 980856



A++-B



L 180

H 350



98086



97313 FAVRIA 1

wall light; aluminium, silver / plastic, white
 Wandleuchte; Alu, silber / Kunststoff, weiss
 applique; aluminium, argent / plastique, blanc

L 125, H 260, A 115

LED
 2x 5,5W
warm WHITE
 2x
 650lm

 IP44

 9 002759 973131
 L 125, H 260, A 115



97314 FAVRIA 1

wall light; aluminium, anthracite / plastic, white
 Wandleuchte; Alu, anthrazit / Kunststoff, weiss
 applique; aluminium, anthracite / plastique, blanc

L 125, H 260, A 115

LED
 2x 5,5W
warm WHITE
 2x
 650lm

 IP44

 9 002759 973148
 L 125, H 260, A 115



97314

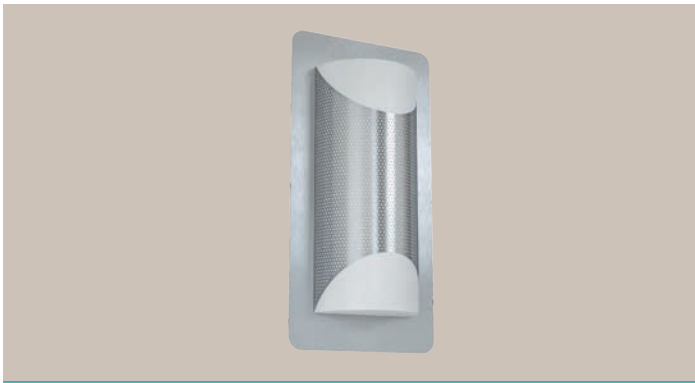

98716 CISTIENA 1

wall light; stainless steel, stainless steel / plastic, white
 Wandleuchte; Edelstahl, edelstahl / Kunststoff, weiss
 applique; acier inoxydable, acier inoxydable / plastique, blanc

L 180, H 350, A 90



9 002759 987169

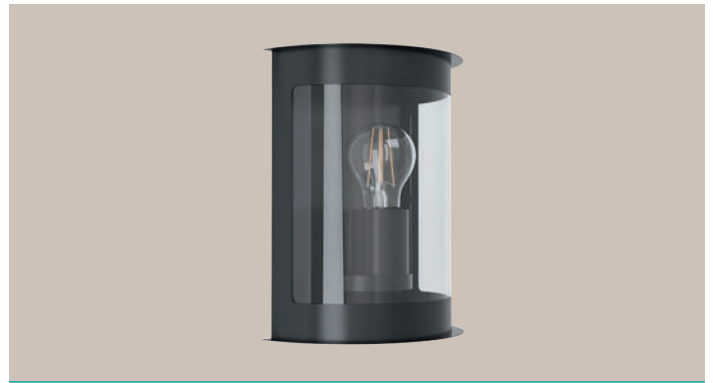

98718 DARIL 1

wall light; zinc-plated steel, black / plastic, transparent
 Wandleuchte; Stahl verzinkt, schwarz / Kunststoff, transparent
 applique; acier galvanisé, noir / plastique, transparent

L 195, H 240, A 110



9 002759 987183



98716



180°, 6 m
 10 sec. - 15 min.

**SAFETY &
 COMFORT**

97284 TRIBANO

wall light; zinc-plated steel, stainless steel / plastic, transparent
 Wandleuchte; Stahl verzinkt, edelstahl / Kunststoff, transparent
 applique; acier galvanisé, acier inoxydable / plastique, transparent

L 200, H 260, A 100



9 002759 972844





94127 TRONO STICK

wall light; stainless steel, stainless steel / glass, plastic, clear
 Wandleuchte; Edelstahl, edelstahl / Glas, Kunststoff, klar
 applique; acier inoxydable, acier inoxydable / verre, plastique, clair

L 105, H 350, A 115

GU10	1x 3W	1x warm WHITE	1x3.7W	1x warm WHITE
		IP44		



94128 TRONO STICK

wall light; stainless steel, stainless steel / glass, plastic, clear
 Wandleuchte; Edelstahl, edelstahl / Glas, Kunststoff, klar
 applique; acier inoxydable, acier inoxydable / verre, plastique, clair

L 105, H 410, A 175

GU10	1x 3W	1x warm WHITE	1x3.7W	1x warm WHITE
		IP44		



98741 FANTECOLO

wall light; stainless steel, stainless steel / glass, clear
 Wandleuchte; Edelstahl, edelstahl / Glas, klar
 applique; acier inoxydable, acier inoxydable / verre, clair

L 100, H 200, A 145

E27	1x 40W	IP44

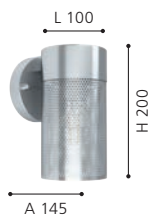



97119 TONEGO

wall light; zinc-plated steel, anthracite / plastic, white
Wandleuchte; Stahl verzinkt, anthrazit / Kunststoff, weiss
applique; acier galvanisé, anthracite / plastique, blanc

L 75, H 310, A 100



9 002759 971199

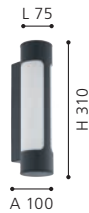

96013 ROBLEDO

wall light; stainless steel, stainless steel / plastic, transparent
Wandleuchte; Edelstahl, edelstahl / Kunststoff, transparent
applique; acier inoxydable, acier inoxydable / plastique, transparent

L 75, H 260, A 120

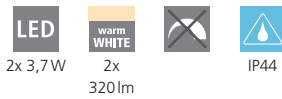

9 002759 960131



86541 BEVERLY

wall light; stainless steel, stainless steel, silver / satin glass, white
Wandleuchte; Edelstahl, edelstahl, silber / Glas satiniert, weiss
applique; acier inoxydable, acier inoxydable, argent / verre satiné, blanc

L 200, H 350, A 135



9 002759 865412

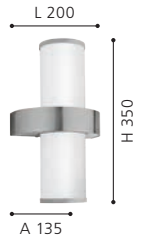

97119



93268 STOCKHOLM 1

wall light; stainless steel, stainless steel / glass, clear
Wandleuchte; Edelstahl, edelstahl / Glas, klar
applique; acier inoxydable, acier inoxydable / verre, clair

Ø 100



9 002759 932688



Ø 100

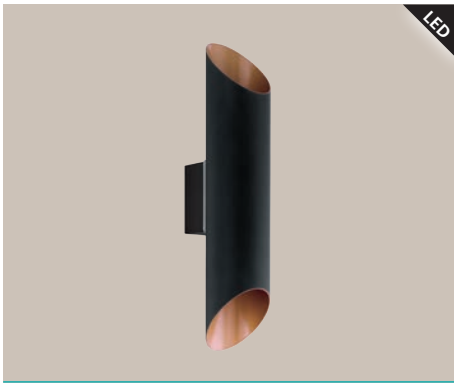

LED

94804 AGOLADA

wall light; zinc-plated steel, black, copper
 Wandleuchte; Stahl verzinkt, schwarz, kupfer
 applique; acier galvanisé, noir, cuivre

L 75, H 360, A 110

2x 3,7W 2x
320lm

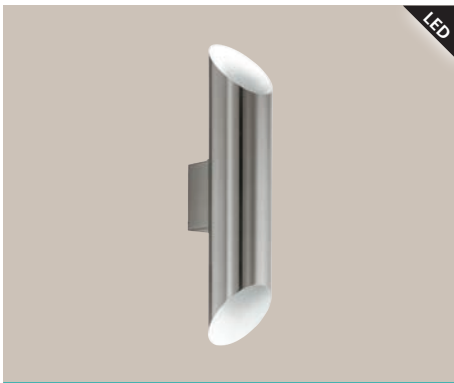

LED

94803 AGOLADA

wall light; stainless steel, stainless steel, white
 Wandleuchte; Edelstahl, edelstahl, weiss
 applique; acier inoxydable, acier inoxydable, blanc

L 75, H 360, A 110

2x 3,7W 2x
320lm

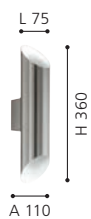

94803



97844



97844 MERLITO

wall light; zinc-plated steel, anthracite / plastic, white
Wandleuchte; Stahl verzinkt, anthrazit / Kunststoff, weiss
applique; acier galvanisé, anthracite / plastique, blanc

L 115, H 185, A 155



97843 MERLITO

wall light; stainless steel, stainless steel / plastic, white
Wandleuchte; Edelstahl, edelstahl / Kunststoff, weiss
applique; acier inoxydable, acier inoxydable / plastique, blanc

L 115, H 185, A 155



92736 RIGA-LED

wall light; stainless steel, stainless steel / plastic, satined
Wandleuchte; Edelstahl, edelstahl / Kunststoff, satiniert
applique; acier inoxydable, acier inoxydable / plastique, satiné

L 65, H 205, A 95



9 002759 978440

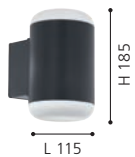

9 002759 978433

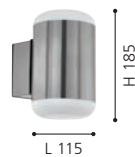

9 002759 927363

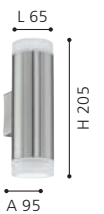



96505 RIGA-LED

wall light; zinc-plated steel, black / plastic, satiné
 Wandleuchte; Stahl verzinkt, schwarz / Kunststoff, satiniert
 applique; acier galvanisé, noir / plastique, satiné

L 65, H 205, A 100

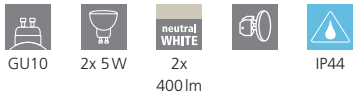

96504 RIGA-LED

wall light; zinc-plated steel, white / plastic, satiné
 Wandleuchte; Stahl verzinkt, weiss / Kunststoff, satiniert
 applique; acier galvanisé, blanc / plastique, satiné

L 65, H 205, A 100



96504



32898 RIGA 5

wall light; stainless steel, stainless steel / glass, clear
 Wandleuchte; Edelstahl, edelstahl / Glas, klar
 applique; acier inoxydable, acier inoxydable / verre, clair

L 65, H 215, A 110

GU10
 2x 3W
 warm WHITE
 2x 240lm

 IP44

9 002759 328986

A+
 INCL.



32899 RIGA 5

wall light; zinc-plated steel, anthracite / glass, clear
 Wandleuchte; Stahl verzinkt, anthrazit / Glas, klar
 applique; acier galvanisé, anthracite / verre, clair

L 65, H 215, A 110

GU10
 2x 3W
 warm WHITE
 2x 240lm

 IP44

9 002759 328993

A+
 INCL.

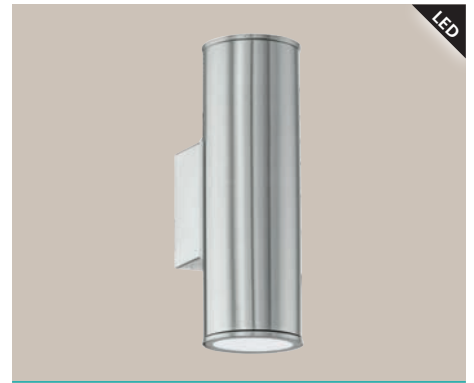

94107 RIGA

wall light; stainless steel, stainless steel
 Wandleuchte; Edelstahl, edelstahl
 applique; acier inoxydable, acier inoxydable

L 65, H 200, A 95

GU10
 2x 3W
 warm WHITE
 2x 240lm
 IP44

9 002759 941079

A+
 INCL.



94107

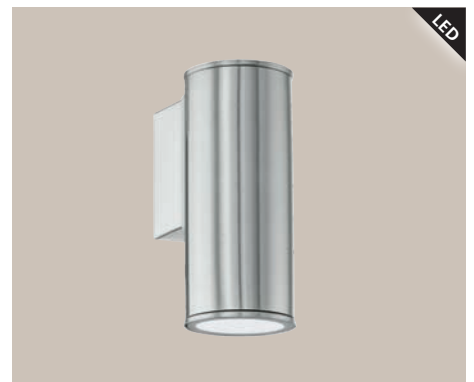

94106 RIGA

wall light; stainless steel, stainless steel
 Wandleuchte; Edelstahl, edelstahl
 applique; acier inoxydable, acier inoxydable

L 65, H 150, A 95

GU10
 1x 3W
 warm WHITE
 1x 240lm
 IP44

9 002759 941062

A+
 INCL.



94101 RIGA

wall light; zinc-plated steel, white
Wandleuchte; Stahl verzinkt, weiss
applique; acier galvanisé, blanc

L 65, H 200, A 95

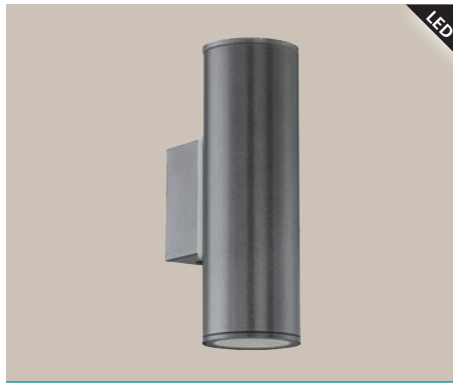
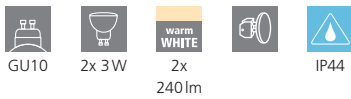

94103 RIGA

wall light; zinc-plated steel, anthracite
Wandleuchte; Stahl verzinkt, anthrazit
applique; acier galvanisé, anthracite

L 65, H 200, A 95

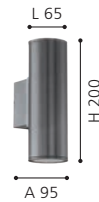
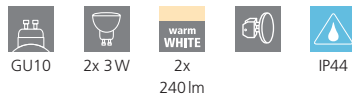

94105 RIGA

wall light; zinc-plated steel, antique-brown
Wandleuchte; Stahl verzinkt, antik-braun
applique; acier galvanisé, marron antique

L 65, H 200, A 95

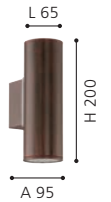
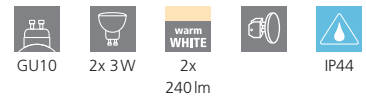

94099 RIGA

wall light; zinc-plated steel, white
Wandleuchte; Stahl verzinkt, weiss
applique; acier galvanisé, blanc

L 65, H 150, A 95

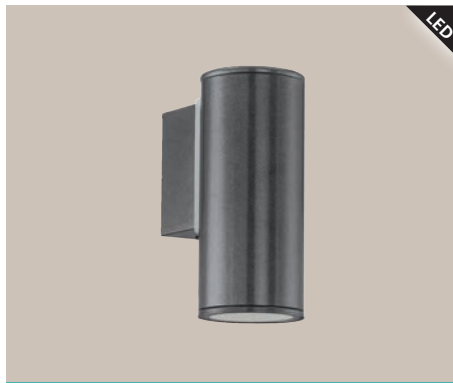

94102 RIGA

wall light; zinc-plated steel, anthracite
Wandleuchte; Stahl verzinkt, anthrazit
applique; acier galvanisé, anthracite

L 65, H 150, A 95

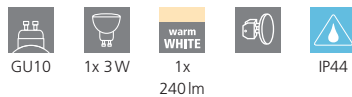



96491 ARGOLIS

wall / ceiling light; cast aluminium, white / plastic, white

Wand- / Deckenleuchte; Aluguss, weiss / Kunststoff, weiss

applique / plafonnier; fonte d'aluminium, blanc / plastique, blanc

H 35, Ø 225



16,5W 1600lm

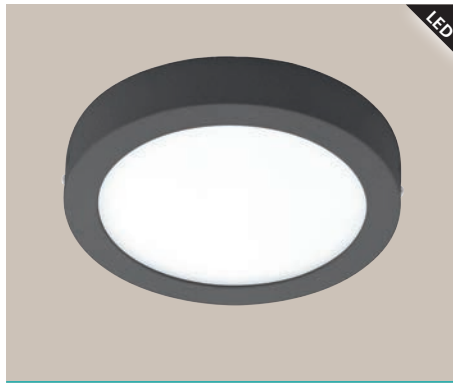

96492 ARGOLIS

wall / ceiling light; cast aluminium, anthracite / plastic, white

Wand- / Deckenleuchte; Aluguss, anthrazit / Kunststoff, weiss

applique / plafonnier; fonte d'aluminium, anthracite / plastique, blanc

H 35, Ø 225



16,5W 1600lm



94784 ONTANEDA

wall / ceiling light; plastic, black / plastic, white

Wand- / Deckenleuchte; Kunststoff, schwarz / Kunststoff, weiss

applique / plafonnier; plastique, noir / plastique, blanc

Ø 325, A 75



8,2W 820lm



9 002759 964917



9 002759 964924



9 002759 947842



94785



94785 ONTANEDA

wall / ceiling light; plastic, white / plastic, white

Wand- / Deckenleuchte; Kunststoff, weiss / Kunststoff, weiss

applique / plafonnier; plastique, blanc / plastique, blanc

Ø 325, A 75



8,2W 820lm



9 002759 947859





96365 VENTO 2

wall / ceiling light; stainless steel, stainless steel / plastic, white

Wand- / Deckenleuchte; Edelstahl, edelstahl / Kunststoff, weiss

applique / plafonnier; acier inoxydable, acier inoxydable / plastique, blanc

Ø 185, A 70



1x 5,4W
1x
410lm



9 002759 963651



94121 VENTO 1

wall / ceiling light; stainless steel, stainless steel / glass, white painted

Wand- / Deckenleuchte; Edelstahl, edelstahl / Glas, weiss lackiert

applique / plafonnier; acier inoxydable, acier inoxydable / verre, blanc laqué

Ø 285, A 80



11W
950lm



9 002759 941215

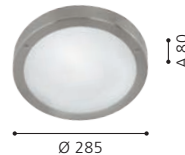

97254 PILONE

wall / ceiling light; steel, plastic, white / plastic, white

Wand- / Deckenleuchte; Stahl, Kunststoff, weiss / Kunststoff, weiss

applique / plafonnier; acier, plastique, blanc / plastique, blanc

H 70, Ø 300



1x 11W
1x
950lm



9 002759 972547

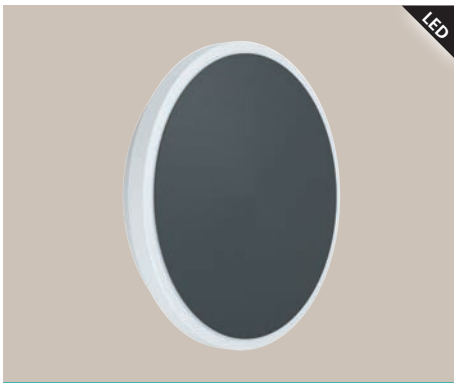

98712 MONGODIO

wall / ceiling light; zinc-plated steel, anthracite / plastic, white

Wand- / Deckenleuchte; Stahl verzinkt, anthrazit / Kunststoff, weiss

applique / plafonnier; acier galvanisé, anthracite / plastique, blanc

H 40, Ø 250



11,5W
1450lm



9 002759 987121

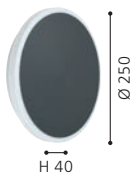

98712



96021 SESIMBA 1

wall light; zinc-plated steel, black / plastic, clear
Wandleuchte; Stahl verzinkt, schwarz / Kunststoff, klar
applique; acier galvanisé, noir / plastique, clair

L 130, H 195, A 140

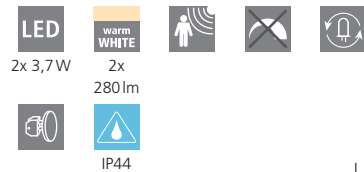

96019 SESIMBA 1

wall light; zinc-plated steel, silver / plastic, clear
Wandleuchte; Stahl verzinkt, silber / Kunststoff, klar
applique; acier galvanisé, argent / plastique, clair

L 130, H 195, A 140



96022 SESIMBA 1

wall light; zinc-plated steel, white / plastic, clear
Wandleuchte; Stahl verzinkt, weiss / Kunststoff, klar
applique; acier galvanisé, blanc / plastique, clair

L 130, H 195, A 140

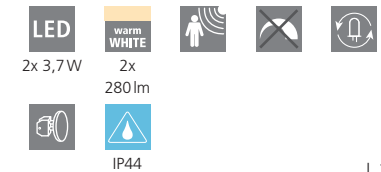

94848 SESIMBA

wall light; zinc-plated steel, black / plastic, clear
Wandleuchte; Stahl verzinkt, schwarz / Kunststoff, klar
applique; acier galvanisé, noir / plastique, clair

L 130, H 195, A 140

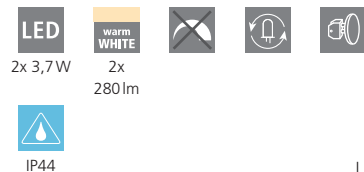

94796 SESIMBA

wall light; zinc-plated steel, silver / plastic, clear
Wandleuchte; Stahl verzinkt, silber / Kunststoff, klar
applique; acier galvanisé, argent / plastique, clair

L 130, H 195, A 140

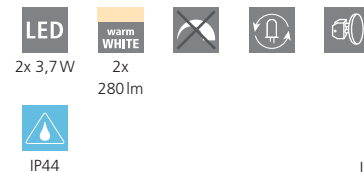



96019



98706 TREVIOLLO 1

wall light; cast aluminium, black / plastic, white
 Wandleuchte; Aluguss, schwarz / Kunststoff, weiss
 applique; fonte d'aluminium, noir / plastique, blanc

L 160, H 85, A 190



98746 TREVIOLLO

wall light; cast aluminium, anthracite / glass, clear
 Wandleuchte; Aluguss, anthrazit / Glas, klar
 applique; fonte d'aluminium, anthracite / verre, clair

L 90, H 85, A 120



98747 TREVIOLLO

wall light; cast aluminium, white / glass, clear
 Wandleuchte; Aluguss, weiss / Glas, klar
 applique; fonte d'aluminium, blanc / verre, clair

L 90, H 85, A 120



98747



93991 BOSARO

wall light; zinc-plated steel, white
Wandleuchte; Stahl verzinkt, weiss
applique; acier galvanisé, blanc

L 170, H 270, A 105



2x 2,5W
2x
180lm



IP44



9 002759 939915



A+



94779 BOSARO

wall light; stainless steel, stainless steel
Wandleuchte; Edelstahl, edelstahl
applique; acier inoxydable, acier inoxydable

L 170, H 270, A 105



2x 2,5W
2x
180lm



IP44



9 002759 947798



A+



93991



90°, 7 m
10 sec. - 4 min.

**SAFETY &
COMFORT**

97238 VERRES

wall light; stainless steel, plastic, stainless steel, white / plastic, white

Wandleuchte; Edelstahl, Kunststoff, edelstahl, weiss / Kunststoff, weiss

applique; acier inoxydable, plastique, acier inoxydable, blanc / plastique, blanc

L 180, H 290, A 90



GL-803

83433 PARK

wall light; cast aluminium, anthracite / satin glass, white

Wandleuchte; Aluguss, anthrazit / Glas satiniert, weiss

applique; fonte d'aluminium, anthracite / verre satiné, blanc

L 200, H 350, A 145



LED

94138 BREGANZO

wall light; zinc-plated steel, anthracite / plastic, white

Wandleuchte; Stahl verzinkt, anthrazit / Kunststoff, weiss

applique; acier galvanisé, anthracite / plastique, blanc

L 180, H 250, A 115



180°, 7 m
10 sec. - 15 min.

**SAFETY &
COMFORT**

97218 MUSSOTTO

wall light; stainless steel, plastic, stainless steel, white / plastic, white

Wandleuchte; Edelstahl, Kunststoff, edelstahl, weiss / Kunststoff, weiss

applique; acier inoxydable, plastique, acier inoxydable, blanc / plastique, blanc

L 210, H 305, A 90



90°, 6 m
10 sec. - 10 min.

**SAFETY &
COMFORT**

96018 BREGANZO 1

wall light; zinc-plated steel, anthracite / plastic, white

Wandleuchte; Stahl verzinkt, anthrazit / Kunststoff, weiss

applique; acier galvanisé, anthracite / plastique, blanc

L 190, H 300, A 125

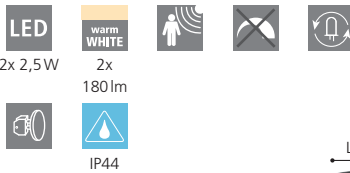

90°, 6 m
10 sec. - 10 min.

**SAFETY &
COMFORT**

96017 BREGANZO 1

wall light; zinc-plated steel, silver / plastic, white

Wandleuchte; Stahl verzinkt, silber / Kunststoff, weiss

applique; acier galvanisé, argent / plastique, blanc

L 190, H 300, A 125

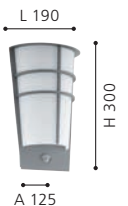
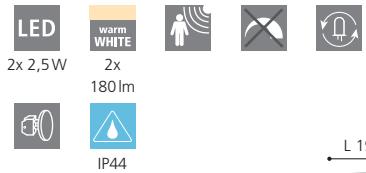



96017



30192 CERNO

wall light; stainless steel, stainless steel / satin glass, white
Wandleuchte; Edelstahl, edelstahl / Glas satiniert, weiss
applique; acier inoxydable, acier inoxydable / verre satiné, blanc

L 140, H 190, A 110

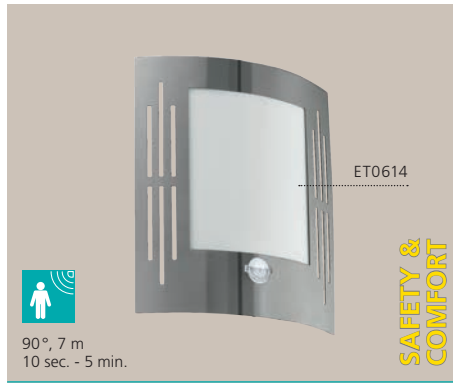

88144 CITY

wall light; stainless steel, stainless steel / plastic, white
Wandleuchte; Edelstahl, edelstahl / Kunststoff, weiss
applique; acier inoxydable, acier inoxydable / plastique, blanc

L 235, H 260, A 90

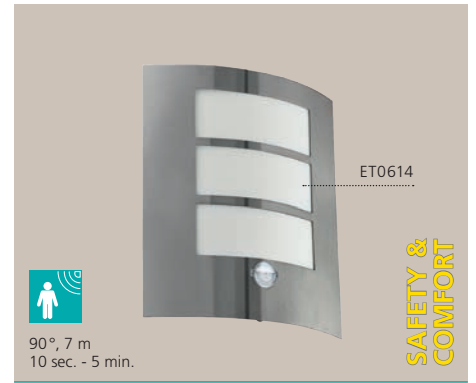

88142 CITY

wall light; stainless steel, stainless steel / plastic, white
Wandleuchte; Edelstahl, edelstahl / Kunststoff, weiss
applique; acier inoxydable, acier inoxydable / plastique, blanc

L 235, H 260, A 90



30191 CERNO

wall light; stainless steel, stainless steel / satin glass, white
Wandleuchte; Edelstahl, edelstahl / Glas satiniert, weiss
applique; acier inoxydable, acier inoxydable / verre satiné, blanc

L 140, H 165, A 105

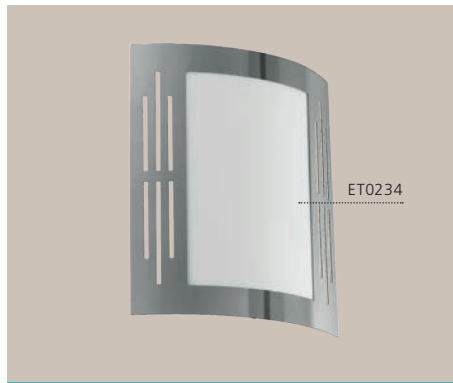

82309 CITY

wall light; stainless steel, stainless steel / plastic, white
Wandleuchte; Edelstahl, edelstahl / Kunststoff, weiss
applique; acier inoxydable, acier inoxydable / plastique, blanc

L 235, H 260, A 90



88139 CITY

wall light; stainless steel, stainless steel / plastic, white
Wandleuchte; Edelstahl, edelstahl / Kunststoff, weiss
applique; acier inoxydable, acier inoxydable / plastique, blanc

L 235, H 260, A 90

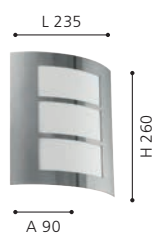



30192



89768 ONJA

wall light; cast aluminium, white / glass fluted, clear
Wandleuchte; Aluguss, weiss / Glas geriffelt, klar
applique; fonte d'aluminium, blanc / verre cannelé, clair

L 220, H 155, A 150

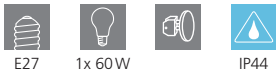

89767 ONJA

wall light; cast aluminium, black / glass fluted, clear
Wandleuchte; Aluguss, schwarz / Glas geriffelt, klar
applique; fonte d'aluminium, noir / verre cannelé, clair

L 220, H 155, A 150



90867 LEPUS

wall light; steel, zinc-plated / plastic, white
Wandleuchte; Stahl, feuerverzinkt / Kunststoff, weiss
applique; acier, galvanisé à chaud / plastique, blanc

L 235, H 120, A 125



89768



ONJA

With direct and indirect light this luminaire creates a spectacular effect.

Diese Leuchten schaffen durch direktes und indirektes Licht einen tollen Effekt.

Ce luminaire crée un effet lumineux special pour une illumination directe et indirecte.

**15
YEARS
GUARANTEE**



96206 ENTRIMO

wall light; zinc-plated steel, zinc-plated / plastic, white
Wandleuchte; Stahl verzinkt, feuerverzinkt / Kunststoff, weiss
applique; acier galvanisé, galvanisé à chaud / plastique, blanc

L 200, H 185, A 235

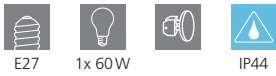

88119 SEVILLA

wall / ceiling light; steel, zinc-plated / satin glass, white
Wand- / Deckenleuchte; Stahl, feuerverzinkt / Glas satiniert, weiss

applique / plafonnier; acier, galvanisé à chaud / verre satiné, blanc

Ø 285, A 83



**88489, 88119,
96206, 90867**

15 years guarantee against corrosion on the hot dipped galvanized surface.

15 Jahre Garantie gegen Korrosion der feuerverzinkten Oberfläche.

Garantie de 15 ans contre la corrosion de la surface galvanisé à chaud.



88489 MILTON

wall light; steel, zinc-plated / glass, clear
Wandleuchte; Stahl, feuerverzinkt / Glas, klar
applique; acier, galvanisé à chaud / verre, clair

H 310, A 310



88119

TOPLINE

TOPLINE - Purist design and high quality materials characterize the exterior lighting program for extraordinary expectations. We are supporting the architecture that creates wellness spaces. Treat yourself to the topline of EGLO.

TOPLINE - Puristisches Design und Hochwertigkeit der Materialien zeichnen das Außenleuchten-Programm für gehobene Ansprüche besonders aus. Wir setzen damit Akzente für die Architektur des Wohlfühl-Raums. Gönnen Sie sich die Topline von EGLO.



TOPLINE - Conception puriste et matériaux de haute qualité caractérisent le programme d'éclairage extérieur pour les clients avec des attentes élevées. Nous avons donc donné le ton pour l'architecture de l'espace bien-être. Offrez-vous la Topline de EGLO.



OVERVIEW

TOPLINE





SAKEDA
106



SAKEDA
106



SAKEDA
106



ABRANTES
107



BELCREDA
108



BELCREDA
108



EMOLLIO
109



EMOLLIO
109



CALPINO
110



CALPINO
110



DESELLA 1
111



ROALES
112



IPHIAS
113



IPHIAS
113



BEVERLY 1
114



BRIONES
114



CHEIRA
114

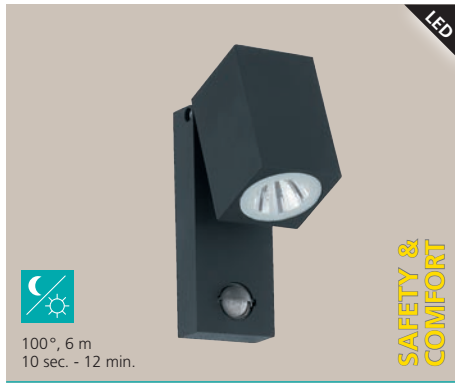
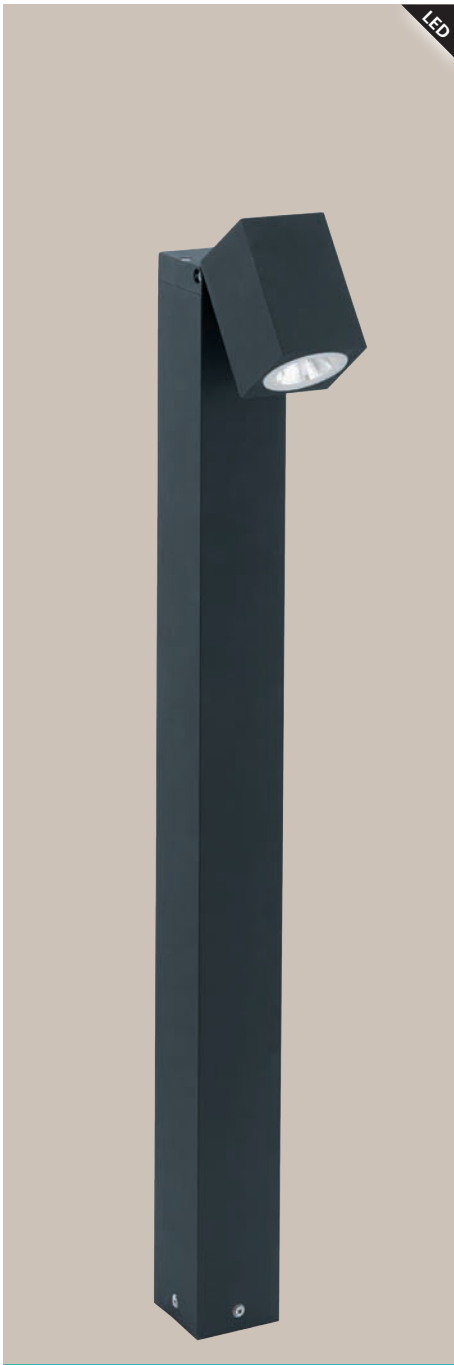

96287 SAKEDA

wall light; cast aluminium, anthracite
Wandleuchte; Aluguss, anthrazit
applique; fonte d'aluminium, anthracite

L 70, H 170, A 100

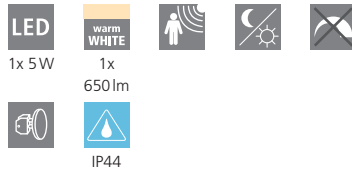

96286 SAKEDA

wall light; cast aluminium, anthracite
Wandleuchte; Aluguss, anthrazit
applique; fonte d'aluminium, anthracite

L 70, H 170, A 100

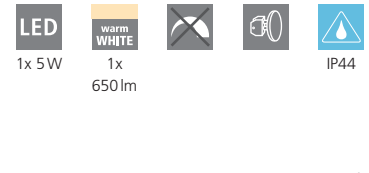

96288 SAKEDA

floor light; cast aluminium, anthracite
Stehleuchte; Aluguss, anthrazit
lampadaire; fonte d'aluminium, anthracite

L 135, B 70, H 780, Base: B 70, T 70





95076 ABRANTES

wall light; cast aluminium, anthracite / glass, clear
Wandleuchte; Aluguss, anthrazit / Glas, klar
applique; fonte d'aluminium, anthracite / verre, clair

L 120, H 200, A 130

LED

2x 6W

warm
WHITE

1300lm



IP44



9 002759 950767

A+

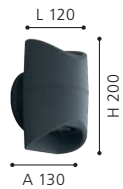

95076

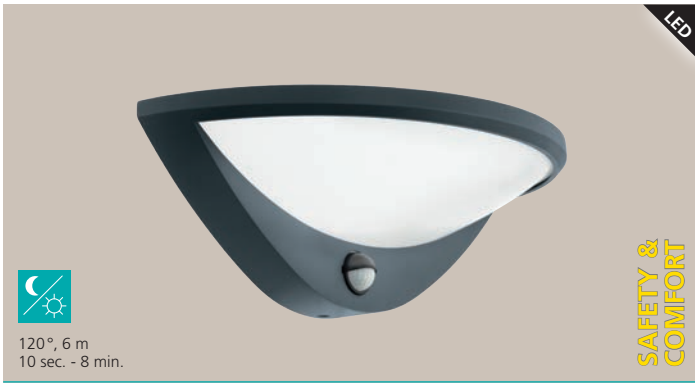

97312 BELCREDA

wall light; cast aluminium, anthracite / plastic, white
 Wandleuchte; Aluguss, anthrazit / Kunststoff, weiss
 applique; fonte d'aluminium, anthracite / plastique, blanc

L 330, H 125, A 165

LED
 9,3W

warm WHITE
 1200lm



A++



97311 BELCREDA

wall light; cast aluminium, white / plastic, white
 Wandleuchte; Aluguss, weiss / Kunststoff, weiss
 applique; fonte d'aluminium, blanc / plastique, blanc

L 330, H 125, A 165

LED
 9,3W

warm WHITE
 1200lm



A++

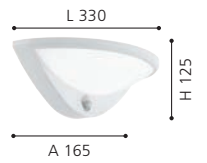



96274 EMOLLIO

wall light; cast aluminium, white / plastic, white
 Wandleuchte; Aluguss, weiss / Kunststoff, weiss
 applique; fonte d'aluminium, blanc / plastique, blanc

L 200, H 160, A 80



96275 EMOLLIO

wall light; cast aluminium, anthracite / plastic, white
 Wandleuchte; Aluguss, anthrazit / Kunststoff, weiss
 applique; fonte d'aluminium, anthracite / plastique, blanc

L 200, H 160, A 80

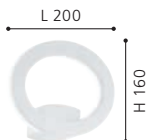



97241 CALPINO

wall light; cast aluminium, white
 Wandleuchte; Aluguss, weiss
 applique; fonte d'aluminium, blanc

L 105, H 105, A 110

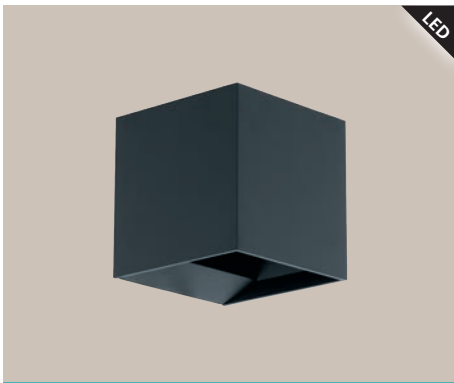
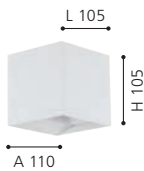

97242 CALPINO

wall light; cast aluminium, anthracite
 Wandleuchte; Aluguss, anthrazit
 applique; fonte d'aluminium, anthracite

L 105, H 105, A 110

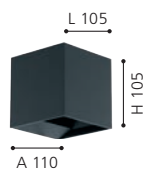



95097 DESELLA 1

wall light; cast aluminium, anthracite / plastic, white
Wandleuchte; Aluguss, anthrazit / Kunststoff, weiss
applique; fonte d'aluminium, anthracite / plastique, blanc

L 160, H 160, A 190

LED
10W

warm
WHITE
900lm



IP54



9 002759 950972

A+

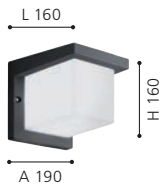

95097

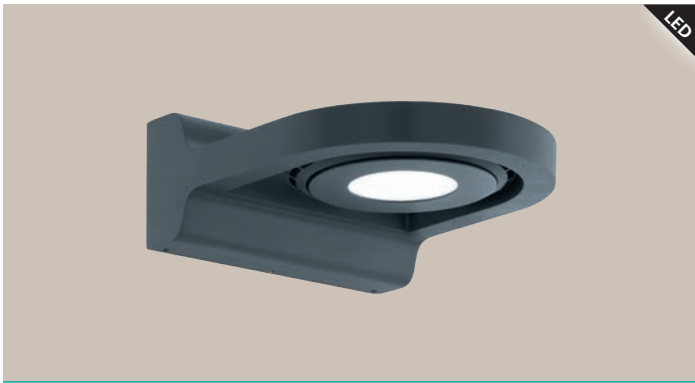

96282 ROALES

wall light; cast aluminium, anthracite / plastic, white
 Wandleuchte; Aluguss, anthrazit / Kunststoff, weiss
 applique; fonte d'aluminium, anthracite / plastique, blanc

L 140, H 60, A 170

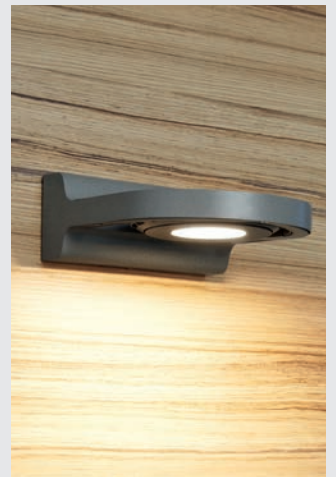
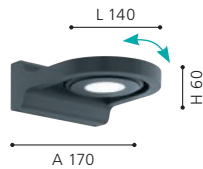

ROALES

With this luminaire you can choose different lighting scenes.

Bei dieser Leuchte können Sie nach Belieben unterschiedliche Lichtszenen wählen.

Vous pouvez sélectionner au choix avec ces luminaire différentes ambiances lumineuses.



96282



96488

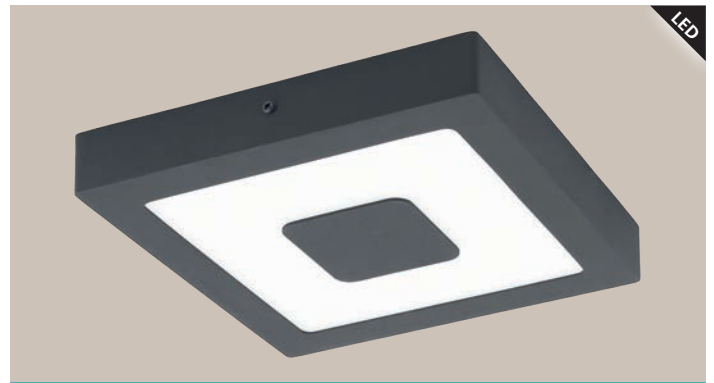
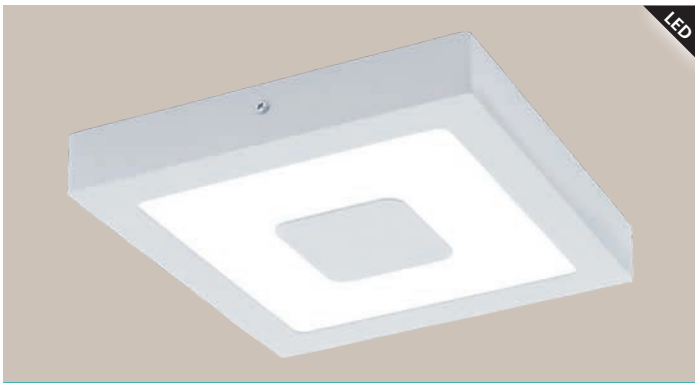

96488 IPHIAS

wall / ceiling light; cast aluminium, white / plastic, white
Wand- / Deckenleuchte; Aluguss, weiss / Kunststoff, weiss
applique / plafonnier; fonte d'aluminium, blanc / plastique, blanc

L 225, B 225, H 40



16,5W 1700lm

96489 IPHIAS

wall / ceiling light; cast aluminium, anthracite / plastic, white
Wand- / Deckenleuchte; Aluguss, anthrazit / Kunststoff, weiss
applique / plafonnier; fonte d'aluminium, anthracite / plastique, blanc

L 225, B 225, H 40



16,5W 1700lm



9 002759 964887

A+



9 002759 964894

A+

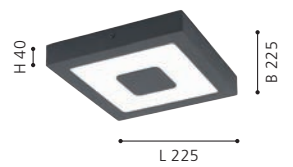



94799 BEVERLY 1

wall light; stainless steel, stainless steel / plastic, white, clear
 Wandleuchte; Edelstahl, edelstahl / Kunststoff, weiss, klar
 applique; acier inoxydable, acier inoxydable / plastique, blanc, clair

L 200, H 270, A 130

LED
 2x 3,7W
 warm WHITE
 2x
 280lm
 IP44



9 002759 947996



95079 BRIONES

wall light; cast aluminium, stainless steel / plastic, white
 Wandleuchte; Aluguss, edelstahl / Kunststoff, weiss
 applique; fonte d'aluminium, acier inoxydable / plastique, blanc

L 85, H 95, A 125

LED
 2x 3W
 warm WHITE
 500lm
 IP44



9 002759 950798

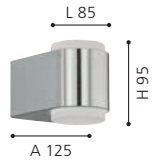

94799



120°, 6 m
 10 sec. - 8 min.

SAFETY & COMFORT

97297 CHEIRA

wall light; cast aluminium, silver / plastic, white
 Wandleuchte; Aluguss, silber / Kunststoff, weiss
 applique; fonte d'aluminium, argent / plastique, blanc

L 295, H 300, A 60

LED
 2x 2,7W
 warm WHITE
 2x
 300lm
 LED
 1x 3,6W
 warm WHITE
 1x
 430lm
 IP44



9 002759 972974

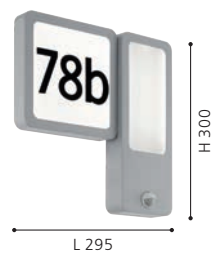



97297



CLASSIC

KLASSIK
CLASSIQUE

TIMELESS CLASSICS - Romantic and nostalgic elements from different materials create unique luminaires for your outdoor area. True classics for a real wellness ambience.

ZEITLOSE KLASSIKER - Romantische und nostalgische Elemente aus unterschiedlichen Materialien kreieren einzigartige Leuchten für Ihren Außenbereich. Wahre Klassiker für echtes Wohlfühlambiente.



CLASSIQUE INTEMPOREL - Des éléments romantiques et nostalgiques issus de différents matériaux forment d' uniques luminaires pour votre extérieur. De véritables classiques pour une vraie ambiance de bien-être.



OVERVIEW

CLASSIC





VILLAGRAZIA
120



CASCINETTA
121



SONCINO
122



MIRANDOLA
122



ALAMONTE
123



CIVIDINO
123



ALAMONTE 1
124



RAVELLO
126



VERLUCCA
127



SIRMIONE
128



SIDNEY
130



LISIO
131



HILBURN
132



PULFERO
135



PULFERO
135



PULFERO 1
135



PULFERO 1
135



MELGOA
136



BARROSELA
136



ENTRIMO
136



CANOVE
136



VALDEO
137



BOVOLONE
137



TRECATE
137



COLINDRES
138



BARROSELA
138



MELGOA
138



MILTON
139



SAN TELMO
139



VALDEO
139



ALBACETE
139



MONREALE
140



MONREALE
142



ALORIA
144



ALORIA
145



ALORIA
146



ALORIA
147



SOSSANO
148



MONSELICE
148



MANERBIO
148



SOSSANO
149



MONSELICE
149



MANERBIO
149



NAVEDO
150



NAVEDO
152



NAVEDO
153



NAVEDO
154



LATERNA 4
156



LATERNA 4
157



LATERNA 5
158



LATERNA 5
159

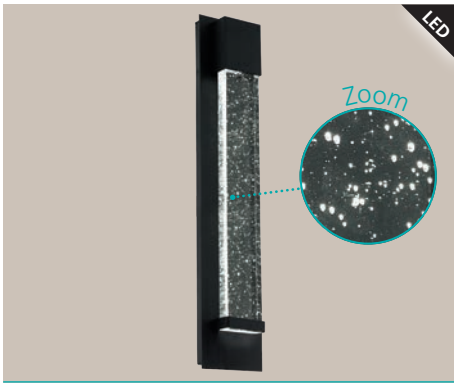

98154 VILLAGRAZIA

wall light; aluminium, black / glass with air inclusions, clear
 Wandleuchte; Alu, schwarz / Glas mit Luft einschüssen, klar
 applique; aluminium, noir / verre avec inclusions d'air, clair

L 120, H 400, A 70

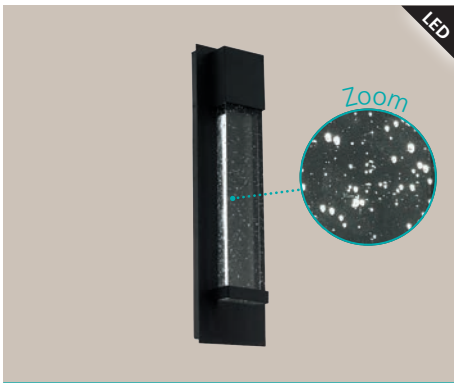
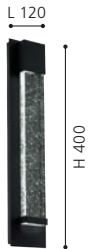

98153 VILLAGRAZIA

wall light; aluminium, black / glass with air inclusions, clear
 Wandleuchte; Alu, schwarz / Glas mit Luft einschüssen, klar
 applique; aluminium, noir / verre avec inclusions d'air, clair

L 120, H 300, A 70



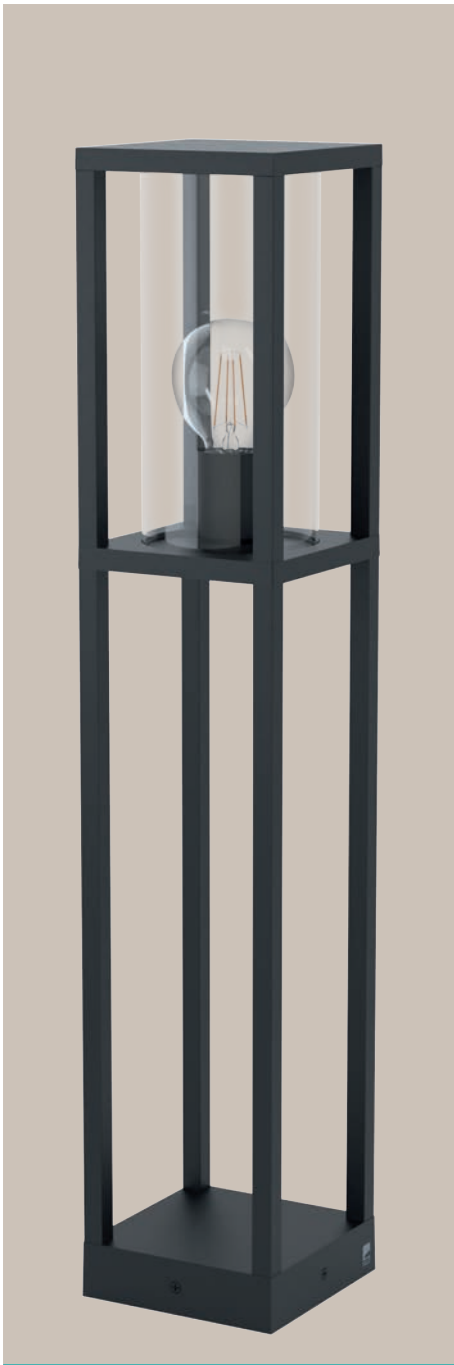

98715 CASCINETTA

floor light; cast aluminium, black / glass, clear
 Stehleuchte; Aluguss, schwarz / Glas, klar
 lampadaire; fonte d'aluminium, noir / verre, clair

L 150, B 150, H 795



98713 CASCINETTA

wall light; zinc-plated steel, black / glass, clear
 Wandleuchte; Stahl verzinkt, schwarz / Glas, klar
 applique; acier galvanisé, noir / verre, clair

L 165, H 280, A 165



98714 CASCINETTA

pedestal light; cast aluminium, black / glass, clear
 Sockelleuchte; Aluguss, schwarz / Glas, klar
 luminaire pour socle; fonte d'aluminium, noir / verre, clair

L 150, H 305, A 150





98719 MIRANDOLA

wall light; cast aluminium, black / glass, clear
Wandleuchte; Aluguss, schwarz / Glas, klar
applique; fonte d'aluminium, noir / verre, clair

L 180, H 270, A 225



97294 SONCINO

wall light; cast aluminium, black / glass, clear
Wandleuchte; Aluguss, schwarz / Glas, klar
applique; fonte d'aluminium, noir / verre, clair

L 265, H 330, A 120

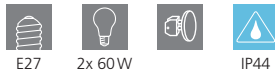

97294



98744 CIVIDINO

wall light; cast aluminium, black / satin glass, white
 Wandleuchte; Aluguss, schwarz / Glas satiniert, weiss
 applique; fonte d'aluminium, noir / verre satiné, blanc

L 120, H 260, A 115



94827 ALAMONTE

wall light; stainless steel, stainless steel / glass, clear
 Wandleuchte; Edelstahl, edelstahl / Glas, klar
 applique; acier inoxydable, acier inoxydable / verre, clair

L 170, H 260, A 100



98744



94833 ALAMONTE 1

floor light; zinc-plated steel, black / glass, clear
 Stehleuchte; Stahl verzinkt, schwarz / Glas, klar
 lampadaire; acier galvanisé, noir / verre, clair

L 150, B 150, H 1015, Base: Ø 110



94831 ALAMONTE 1

wall light; zinc-plated steel, black / glass, clear
 Wandleuchte; Stahl verzinkt, schwarz / Glas, klar
 applique; acier galvanisé, noir / verre, clair

L 170, H 260, A 100



94789 ALAMONTE 1

table light; zinc-plated steel, black / glass, clear
 Tischleuchte; Stahl verzinkt, schwarz / Glas, klar
 luminaire de table; acier galvanisé, noir / verre, clair

L 150, B 150, H 275

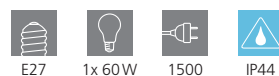

94832 ALAMONTE 1

wall / ceiling light; zinc-plated steel, black / glass, clear
 Wand- / Deckenleuchte; Stahl verzinkt, schwarz / Glas, klar
 applique / plafonnier; acier galvanisé, noir / verre, clair

L 290, H 290, A 130

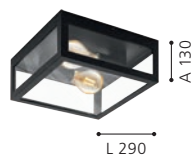

98273 ALAMONTE 1

wall light; zinc-plated steel, black / glass, clear
 Wandleuchte; Stahl verzinkt, schwarz / Glas, klar
 applique; acier galvanisé, noir / verre, clair

L 150, H 380, A 100





94788 ALAMONTE 1

pendant light; zinc-plated steel, black / glass, clear
 Hängeleuchte; Stahl verzinkt, schwarz / Glas, klar
 luminaire en suspension; acier galvanisé, noir / verre, clair

L 150, B 150, H 1285



E27



1x 60W



IP44



9 002759 947880



A++-E



94789



98724 RAVELLO

floor light; zinc-plated steel, black / plastic, white
 Stehleuchte; Stahl verzinkt, schwarz / Kunststoff, weiss
 lampadaire; acier galvanisé, noir / plastique, blanc

H 1100, Ø 165, Base: Ø 115

E27
 1x 28W
 IP44

9 002759 987244



98721 RAVELLO

wall light; zinc-plated steel, black / plastic, white
 Wandleuchte; Stahl verzinkt, schwarz / Kunststoff, weiss
 applique; acier galvanisé, noir / plastique, blanc

L 165, H 275, A 225

E27
 1x 28W
 IP44

9 002759 987213



98722 RAVELLO

wall light; zinc-plated steel, black / plastic, white
 Wandleuchte; Stahl verzinkt, schwarz / Kunststoff, weiss
 applique; acier galvanisé, noir / plastique, blanc

L 165, H 320, A 225

E27
 1x 28W

 IP44

9 002759 987220



98723 RAVELLO

pedestal light; zinc-plated steel, black / plastic, white
 Sockelleuchte; Stahl verzinkt, schwarz / Kunststoff, weiss
 luminaire pour socle; acier galvanisé, noir / plastique, blanc

H 450, Ø 165, Base: Ø 115

E27
 1x 28W
 IP44

9 002759 987237



97245 VERLUCCA

floor light; zinc-plated steel, black / glass, clear, black
 Stehleuchte; Stahl verzinkt, schwarz / Glas, klar, schwarz
 lampadaire; acier galvanisé, noir / verre, clair, noir

H 990, Ø 210, Base: Ø 140



97244 VERLUCCA

wall light; zinc-plated steel, black / glass, clear, black
 Wandleuchte; Stahl verzinkt, schwarz / Glas, klar, schwarz
 applique; acier galvanisé, noir / verre, clair, noir

L 210, H 265, A 245

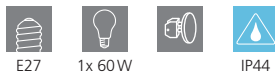

97445 VERLUCCA

wall light; zinc-plated steel, black / glass, clear, black
 Wandleuchte; Stahl verzinkt, schwarz / Glas, klar, schwarz
 applique; acier galvanisé, noir / verre, clair, noir

L 210, H 335, A 220



97244



97287 SIRMIONE

floor light; zinc-plated steel, black, gold / glass opal-matt, white
 Stehleuchte; Stahl verzinkt, schwarz, gold / Glas opal-matt, weiss
 lampadaire; acier galvanisé, noir, or / verre opale mat, blanc

L 340, B 270, H 1200, Base: Ø 110

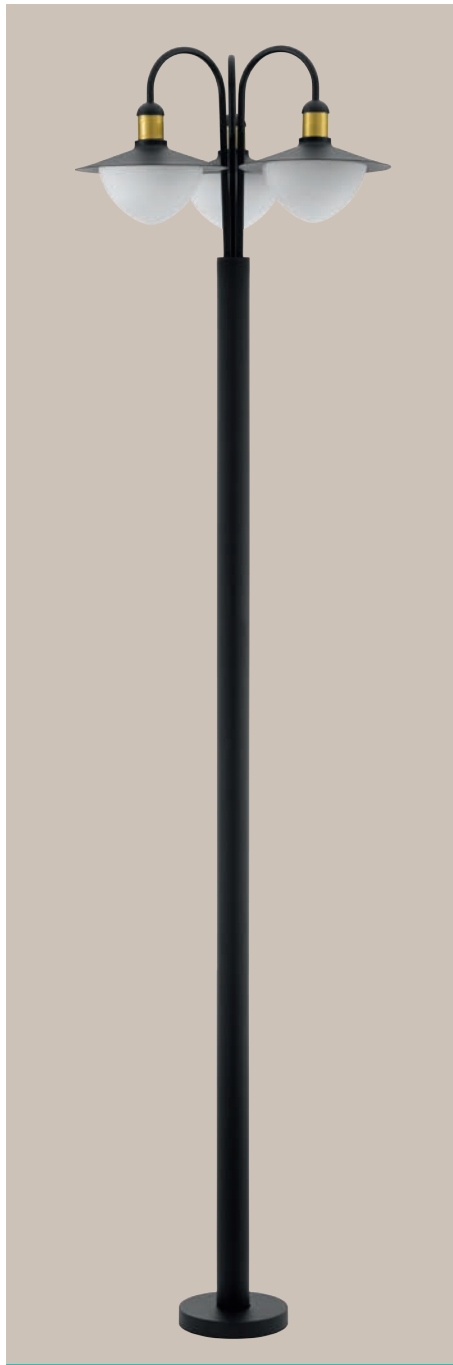
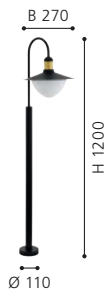

97288 SIRMIONE

floor light; zinc-plated steel, black, gold / glass opal-matt, white
 Stehleuchte; Stahl verzinkt, schwarz, gold / Glas opal-matt, weiss
 lampadaire; acier galvanisé, noir, or / verre opale mat, blanc

H 2200, Ø 550, Base: Ø 200



97285 SIRMIONE

wall light; zinc-plated steel, black, gold / glass opal-matt, white
 Wandleuchte; Stahl verzinkt, schwarz, gold / Glas opal-matt, weiss
 applique; acier galvanisé, noir, or / verre opale mat, blanc

L 270, H 375, A 330



97286 SIRMIONE

wall light; zinc-plated steel, black, gold / glass opal-matt, white
 Wandleuchte; Stahl verzinkt, schwarz, gold / Glas opal-matt, weiss
 applique; acier galvanisé, noir, or / verre opale mat, blanc

L 270, H 375, A 330





97285

97287

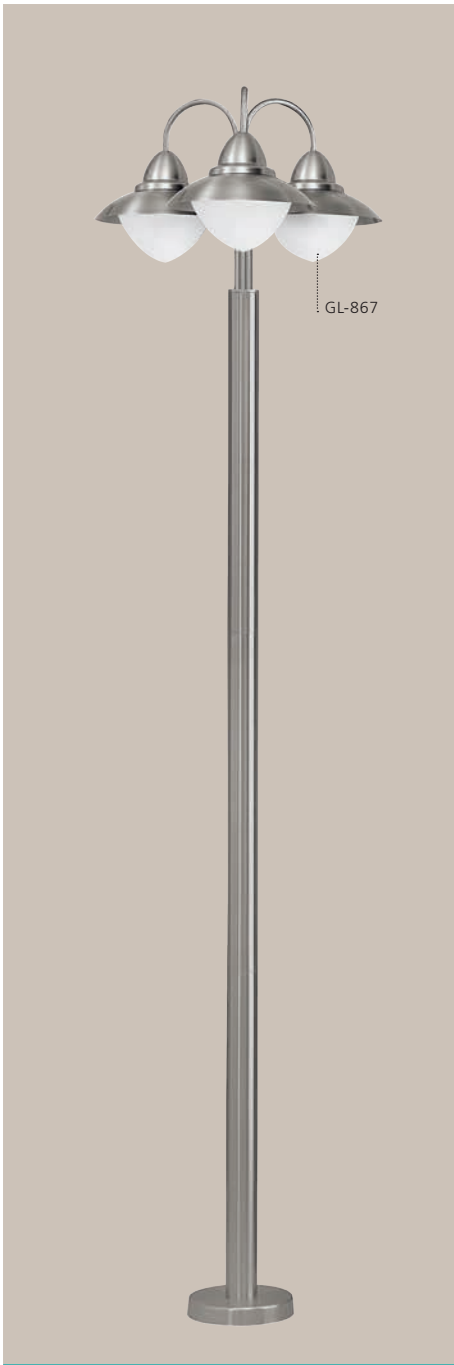

GL-867

83971 SIDNEY

floor light; stainless steel, stainless steel / glass opal-matt, white
Stehleuchte; Edelstahl, edelstahl / Glas opal-matt, weiss
lampadaire; acier inoxydable, acier inoxydable / verre opale mat, blanc

H 2200, Ø 600, Base: Ø 200



E27 3x 60W IP44

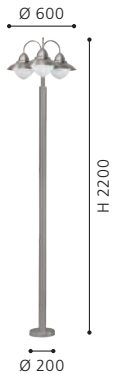

9 002759 839710



GL-867

83966 SIDNEY

wall light; stainless steel, stainless steel / glass opal-matt, white
Wandleuchte; Edelstahl, edelstahl / Glas opal-matt, weiss
applique; acier inoxydable, acier inoxydable / verre opale mat, blanc

H 375, Ø 270, A 325



E27 1x 60W IP44



9 002759 839666



GL-867



120°, 6 m
5 sec. - 8 min.

87105 SIDNEY

wall light; stainless steel, stainless steel / glass opal-matt, white
Wandleuchte; Edelstahl, edelstahl / Glas opal-matt, weiss
applique; acier inoxydable, acier inoxydable / verre opale mat, blanc

H 375, Ø 275, A 325



E27 1x 60W IP44



9 002759 871055



SAFETY &
COMFORT



30187

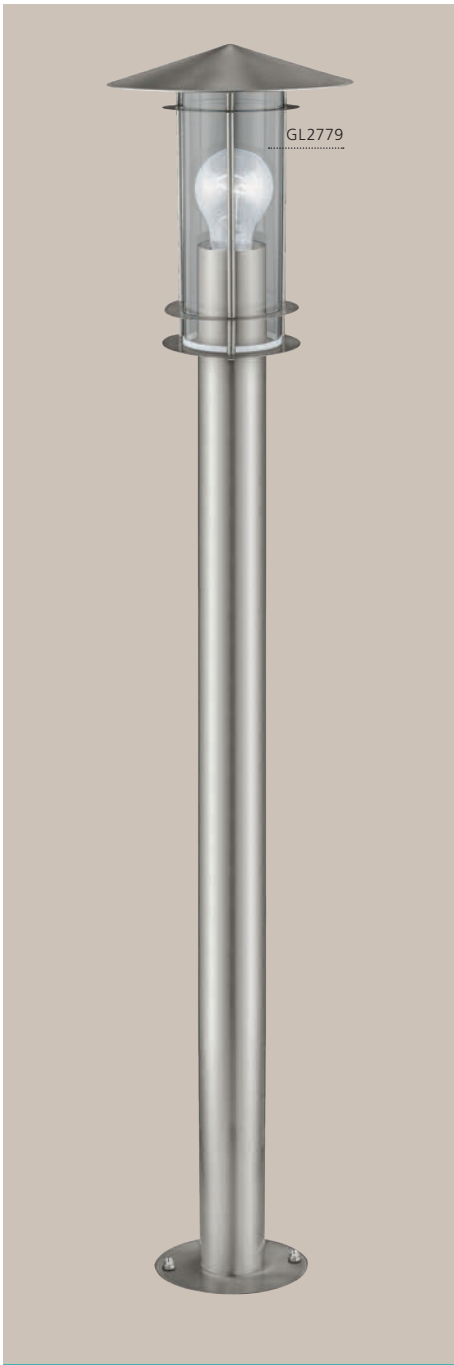

30188 LISIO

floor light; stainless steel, stainless steel / glass, clear
 Stehleuchte; Edelstahl, edelstahl / Glas, klar
 lampadaire; acier inoxydable, acier inoxydable / verre, clair

H 1000, Ø 175, Base: Ø 130

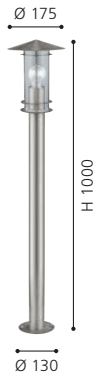

9 002759 301880

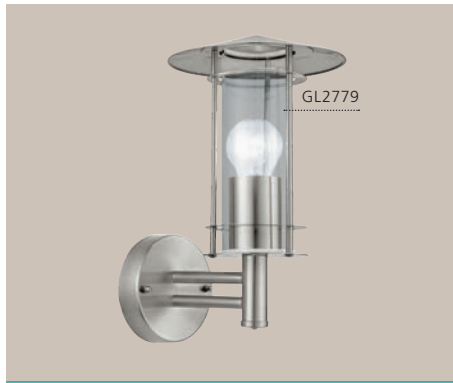

30184 LISIO

wall light; stainless steel, stainless steel / glass, clear
 Wandleuchte; Edelstahl, edelstahl / Glas, klar
 applique; acier inoxydable, acier inoxydable / verre, clair

L 175, H 300, A 225



9 002759 301842

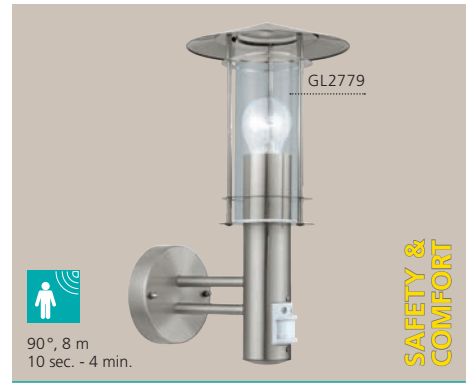

30185 LISIO

wall light; stainless steel, stainless steel / glass, clear
 Wandleuchte; Edelstahl, edelstahl / Glas, klar
 applique; acier inoxydable, acier inoxydable / verre, clair

L 175, H 360, A 225

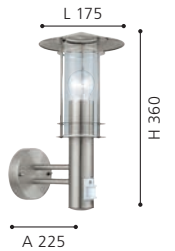

9 002759 301859



**SAFETY &
COMFORT**

90°, 8 m
10 sec. - 4 min.



30187 LISIO

floor light; stainless steel, stainless steel / glass, clear
 Stehleuchte; Edelstahl, edelstahl / Glas, klar
 lampadaire; acier inoxydable, acier inoxydable / verre, clair

H 500, Ø 175, Base: Ø 130

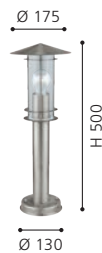

9 002759 301873





94842 HILBURN

wall light; zinc-plated steel, black / plastic, transparent
Wandleuchte; Stahl verzinkt, schwarz / Kunststoff, transparent
applique; acier galvanisé, noir / plastique, transparent

L 200, H 375, A 170



94843 HILBURN

wall light; zinc-plated steel, black / plastic, transparent
Wandleuchte; Stahl verzinkt, schwarz / Kunststoff, transparent
applique; acier galvanisé, noir / plastique, transparent

L 200, H 280, A 200



94864 HILBURN

pedestal light; zinc-plated steel, black / plastic, transparent
Sockelleuchte; Stahl verzinkt, schwarz / Kunststoff, transparent
luminaire pour socle; acier galvanisé, noir / plastique, transparent

L 200, B 135, H 410, Base: Ø 110



94865 HILBURN 1

wall light; zinc-plated steel, silver-antique / plastic, transparent
Wandleuchte; Stahl verzinkt, silber-antik / Kunststoff, transparent
applique; acier galvanisé, argent antique / plastique, transparent

L 200, H 375, A 170

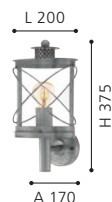

94866 HILBURN 1

wall light; zinc-plated steel, silver-antique / plastic, transparent
Wandleuchte; Stahl verzinkt, silber-antik / Kunststoff, transparent
applique; acier galvanisé, argent antique / plastique, transparent

L 200, H 280, A 200

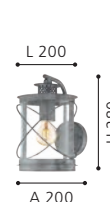

94867 HILBURN 1

pedestal light; zinc-plated steel, silver-antique / plastic, transparent
Sockelleuchte; Stahl verzinkt, silber-antik / Kunststoff, transparent
luminaire pour socle; acier galvanisé, argent antique / plastique, transparent

L 200, B 135, H 410, Base: Ø 110





94865



94834



94855 PULFERO 1

wall light; zinc-plated steel, brown / plastic, transparent
 Wandleuchte; Stahl verzinkt, braun / Kunststoff, transparent
 applique; acier galvanisé, marron / plastique, transparent

L 220, H 280, A 280

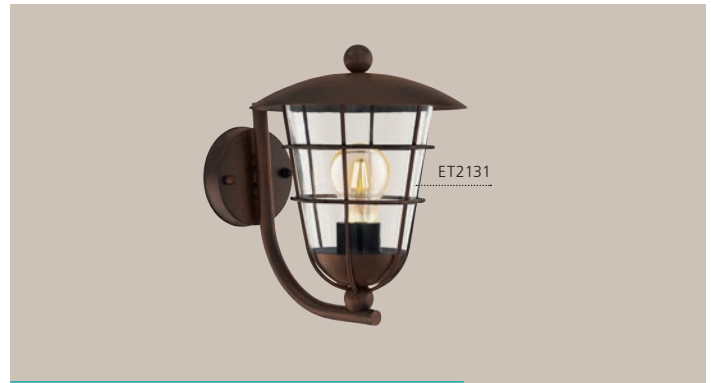

94854 PULFERO 1

wall light; zinc-plated steel, brown / plastic, transparent
 Wandleuchte; Stahl verzinkt, braun / Kunststoff, transparent
 applique; acier galvanisé, marron / plastique, transparent

L 220, H 280, A 280

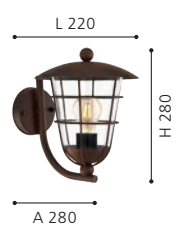
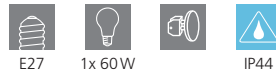

94841 PULFERO

wall light; zinc-plated steel, black / plastic, transparent
 Wandleuchte; Stahl verzinkt, schwarz / Kunststoff, transparent
 applique; acier galvanisé, noir / plastique, transparent

L 220, H 280, A 280



94834 PULFERO

wall light; zinc-plated steel, black / plastic, transparent
 Wandleuchte; Stahl verzinkt, schwarz / Kunststoff, transparent
 applique; acier galvanisé, noir / plastique, transparent

L 220, H 280, A 280





GL3396

94792 MELGOA

wall light; zinc-plated steel, black / glass, clear
Wandleuchte; Stahl verzinkt, schwarz / Glas, klar
applique; acier galvanisé, noir / verre, clair

L 300, H 250, A 380



9 002759 947927



ET2397

94805 BARROSELA

wall light; zinc-plated steel, black / plastic, white
Wandleuchte; Stahl verzinkt, schwarz / Kunststoff, weiss
applique; acier galvanisé, noir / plastique, blanc

L 220, H 240, A 230



9 002759 948054



97226 CANOVE

wall light; zinc-plated steel, black / glass, clear, satiné
Wandleuchte; Stahl verzinkt, schwarz / Glas, klar, satiniert
applique; acier galvanisé, noir / verre, clair, satiné

L 230, H 240, A 235

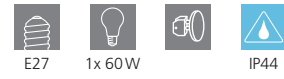

9 002759 972264

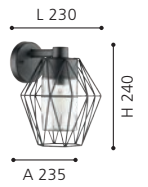

94792



96207 ENTRIMO

wall light; zinc-plated steel, black / plastic, white
Wandleuchte; Stahl verzinkt, schwarz / Kunststoff, weiss
applique; acier galvanisé, noir / plastique, blanc

L 200, H 185, A 235



9 002759 962074



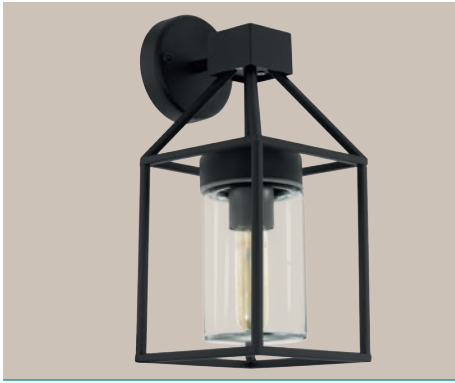

97296 TRECATE

wall light; zinc-plated steel, black / glass, clear
Wandleuchte; Stahl verzinkt, schwarz / Glas, klar
applique; acier galvanisé, noir / verre, clair

L 160, H 355, A 130

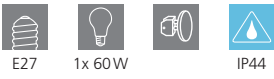

96239 VALDEO

wall light; zinc-plated steel, black / glass, clear
Wandleuchte; Stahl verzinkt, schwarz / Glas, klar
applique; acier galvanisé, noir / verre, clair

L 165, H 275, A 200



97261 BOVOLONE

wall light; zinc-plated steel, black / glass, clear
Wandleuchte; Stahl verzinkt, schwarz / Glas, klar
applique; acier galvanisé, noir / verre, clair

L 110, H 340, A 155

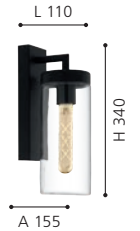
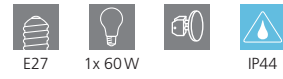

97296





94863 MELGOA

wall light; zinc-plated steel, copper-coloured antique / glass, clear
 Wandleuchte; Stahl verzinkt, kupferfarben-antik / Glas, klar
 applique; acier galvanisé, cuivré antique / verre, clair

L 300, H 250, A 380

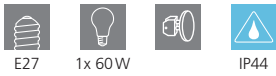

94858 BARROSELA

wall light; zinc-plated steel, copper-coloured antique / plastic, white
 Wandleuchte; Stahl verzinkt, kupferfarben-antik / Kunststoff, weiss

applique; acier galvanisé, cuivré antique / plastique, blanc

L 220, H 240, A 230



94838 COLINDRES

wall light; zinc-plated steel, copper-coloured antique / plastic, white
 Wandleuchte; Stahl verzinkt, kupferfarben-antik / Kunststoff, weiss
 applique; acier galvanisé, cuivré antique / plastique, blanc

L 215, H 290, A 275





90184 SAN TELMO

wall light; zinc-plated steel, cast aluminium, antique-brown / glass with air inclusions, clear
 Wandleuchte; Stahl verzinkt, Aluguss, antik-braun / Glas mit Lufteinschlüssen, klar
 applique; acier galvanisé, fonte d'aluminium, marron antique / verre avec inclusions d'air, clair

L 180, H 350, A 240



96241 VALDEO

wall light; zinc-plated steel, copper-coloured antique / glass, clear
 Wandleuchte; Stahl verzinkt, kupferfarben-antik / Glas, klar
 applique; acier galvanisé, cuivré antique / verre, clair

L 165, H 275, A 200

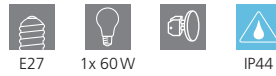

96262 ALBACETE

wall light; zinc-plated steel, brown, copper / glass with air inclusions, clear
 Wandleuchte; Stahl verzinkt, braun, kupfer / Glas mit Lufteinschlüssen, klar
 applique; acier galvanisé, marron, cuivre / verre avec inclusions d'air, clair

L 265, H 255, A 280



83589 MILTON

wall light; zinc-plated steel, antique-brown / glass, clear
 Wandleuchte; Stahl verzinkt, antik-braun / Glas, klar
 applique; acier galvanisé, marron antique / verre, clair

B 240, H 310, A 300

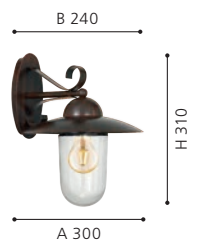



98123 MONREALE

floor light; cast aluminium, black / plastic, transparent
 Stehleuchte; Aluguss, schwarz / Kunststoff, transparent
 lampadaire; fonte d'aluminium, noir / plastique, transparent

H 995, Ø 230, Base: Ø 110

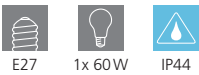

98121 MONREALE

wall light; cast aluminium, black / plastic, transparent
 Wandleuchte; Aluguss, schwarz / Kunststoff, transparent
 applique; fonte d'aluminium, noir / plastique, transparent

L 230, H 275, A 255

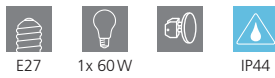

98119 MONREALE

wall light; cast aluminium, black / plastic, transparent
 Wandleuchte; Aluguss, schwarz / Kunststoff, transparent
 applique; fonte d'aluminium, noir / plastique, transparent

L 230, H 275, A 255

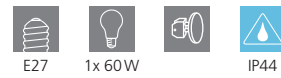

98122 MONREALE

pedestal light; cast aluminium, black / plastic, transparent
 Sockelleuchte; Aluguss, schwarz / Kunststoff, transparent
 luminaire pour socle; fonte d'aluminium, noir / plastique, transparent

H 335, Ø 230, Base: Ø 110





98121

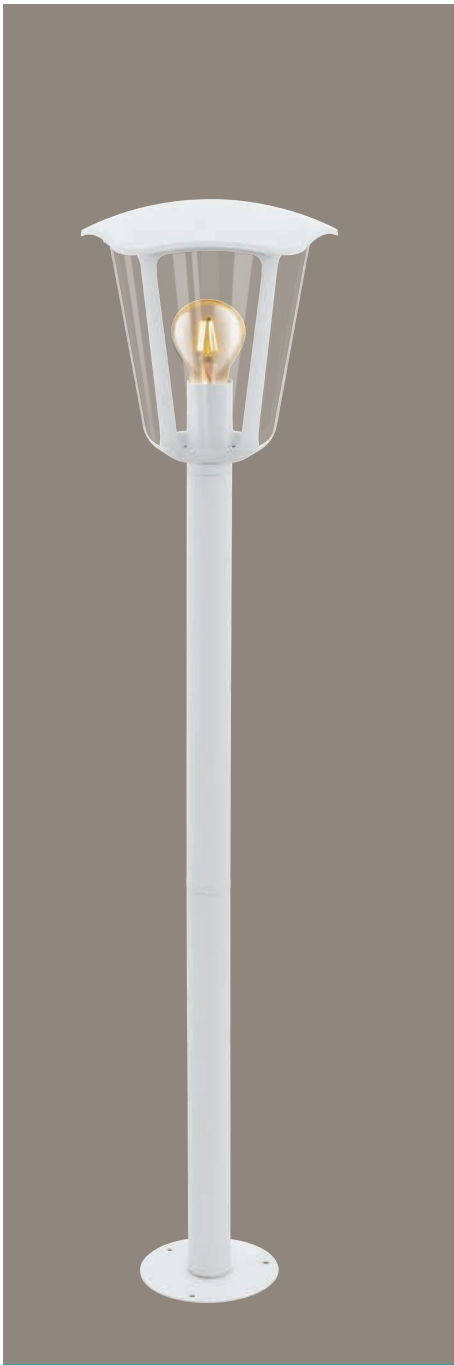

98118 MONREALE

floor light; cast aluminium, white / plastic, transparent
 Stehleuchte; Aluguss, weiss / Kunststoff, transparent
 lampadaire; fonte d'aluminium, blanc / plastique, transparent

H 995, Ø 230, Base: Ø 110

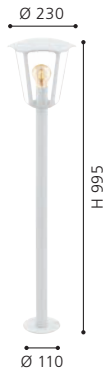

98116 MONREALE

wall light; cast aluminium, white / plastic, transparent
 Wandleuchte; Aluguss, weiss / Kunststoff, transparent
 applique; fonte d'aluminium, blanc / plastique, transparent

L 230, H 275, A 255

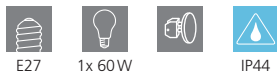

98115 MONREALE

wall light; cast aluminium, white / plastic, transparent
 Wandleuchte; Aluguss, weiss / Kunststoff, transparent
 applique; fonte d'aluminium, blanc / plastique, transparent

L 230, H 275, A 255

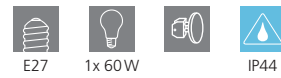

98117 MONREALE

pedestal light; cast aluminium, white / plastic, transparent
 Sockelleuchte; Aluguss, weiss / Kunststoff, transparent
 luminaire pour socle; fonte d'aluminium, blanc / plastique, transparent

H 335, Ø 230, Base: Ø 110



167

98118





93406 ALORIA

pendant light; cast aluminium, black / plastic, clear
 Hängeleuchte; Aluguss, schwarz / Kunststoff, klar
 luminaire en suspension; fonte d'aluminium, noir / plastique, clair

L 170, B 170, H 685

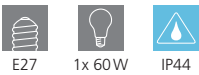

E27 1x 60W IP44

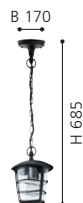

9 002759 934064



93409 ALORIA

floor light; cast aluminium, black / plastic, clear
 Stehleuchte; Aluguss, schwarz / Kunststoff, klar
 lampadaire; fonte d'aluminium, noir / plastique, clair

H 1800, Ø 480, Base: Ø 215



E27 3x 60W IP44



9 002759 934095



93408 ALORIA

floor light; cast aluminium, black / plastic, clear
 Stehleuchte; Aluguss, schwarz / Kunststoff, klar
 lampadaire; fonte d'aluminium, noir / plastique, clair

L 170, B 170, H 940, Base: Ø 170



E27 1x 60W IP44

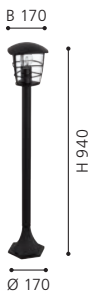

9 002759 934088





93097 ALORIA

wall light; cast aluminium, black / plastic, clear
Wandleuchte; Aluguss, schwarz / Kunststoff, klar
applique; fonte d'aluminium, noir / plastique, clair

L 170, H 225, A 190

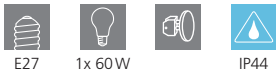

93098 ALORIA

wall light; cast aluminium, black / plastic, clear
Wandleuchte; Aluguss, schwarz / Kunststoff, klar
applique; fonte d'aluminium, noir / plastique, clair

L 170, H 225, A 190



93407 ALORIA

wall light; cast aluminium, black / plastic, clear
Wandleuchte; Aluguss, schwarz / Kunststoff, klar
applique; fonte d'aluminium, noir / plastique, clair

L 180, H 200, A 120



93099 ALORIA

pedestal light; cast aluminium, black / plastic, clear
Sockelleuchte; Aluguss, schwarz / Kunststoff, klar
luminaire pour socle; fonte d'aluminium, noir / plastique, clair

L 170, B 170, H 300, Base: Ø 170





93402 ALORIA

pendant light; cast aluminium, white / plastic, clear
 Hängeleuchte; Aluguss, weiss / Kunststoff, klar
 luminaire en suspension; fonte d'aluminium, blanc / plastique, clair

L 170, B 170, H 685



93405 ALORIA

floor light; cast aluminium, white / plastic, clear
 Stehleuchte; Aluguss, weiss / Kunststoff, klar
 lampadaire; fonte d'aluminium, blanc / plastique, clair

H 1800, Ø 480, Base: Ø 215



93404 ALORIA

floor light; cast aluminium, white / plastic, clear
 Stehleuchte; Aluguss, weiss / Kunststoff, klar
 lampadaire; fonte d'aluminium, blanc / plastique, clair

L 170, B 170, H 940, Base: Ø 170





93094 ALORIA

wall light; cast aluminium, white / plastic, clear
Wandleuchte; Aluguss, weiss / Kunststoff, klar
applique; fonte d'aluminium, blanc / plastique, clair

L 170, H 225, A 190



93095 ALORIA

wall light; cast aluminium, white / plastic, clear
Wandleuchte; Aluguss, weiss / Kunststoff, klar
applique; fonte d'aluminium, blanc / plastique, clair

L 170, H 225, A 190

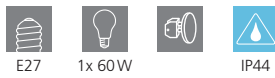

93403 ALORIA

wall light; cast aluminium, white / plastic, clear
Wandleuchte; Aluguss, weiss / Kunststoff, klar
applique; fonte d'aluminium, blanc / plastique, clair

L 180, H 200, A 120



93096 ALORIA

pedestal light; cast aluminium, white / plastic, clear
Sockelleuchte; Aluguss, weiss / Kunststoff, klar
luminaire pour socle; fonte d'aluminium, blanc / plastique, clair

L 170, B 170, H 300, Base: Ø 170



93403



97153 SOSSANO

wall light; plastic, black / glass with air inclusions, clear
Wandleuchte; Kunststoff, schwarz / Glas mit Lufteinschlüssen, klar
applique; plastique, noir / verre avec inclusions d'air, clair

L 200, H 335, A 210



E27 1x 28W



IP44



9 002759 971533



97259 MANERBIO

wall light; cast aluminium, black / glass, clear
Wandleuchte; Aluguss, schwarz / Glas, klar
applique; fonte d'aluminium, noir / verre, clair

L 240, H 295, A 125



E27 1x 60W IP44



IP44



9 002759 972592



97257 MONSELICE

wall light; plastic, black / glass, black, clear
Wandleuchte; Kunststoff, schwarz / Glas, schwarz, klar
applique; plastique, noir / verre, noir, clair

L 195, H 430, A 205



E27 1x 28W



IP44



9 002759 972578





97155 SOSSANO

wall light; plastic, white / glass with air inclusions, clear
 Wandleuchte; Kunststoff, weiss / Glas mit Lufteinschlüssen, klar
 applique; plastique, blanc / verre avec inclusions d'air, clair

L 200, H 335, A 210

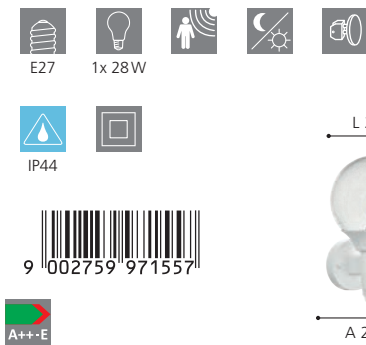

97258 MANERBIO

wall light; cast aluminium, white / glass, clear
 Wandleuchte; Aluguss, weiss / Glas, klar
 applique; fonte d'aluminium, blanc / verre, clair

L 240, H 295, A 125

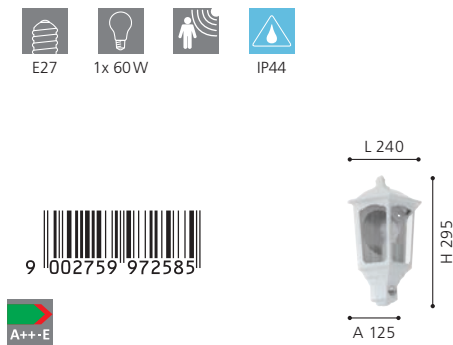

97256 MONSELICE

wall light; plastic, white / glass, white, clear
 Wandleuchte; Kunststoff, weiss / Glas, weiss, klar
 applique; plastique, blanc / verre, blanc, clair

L 195, H 430, A 205

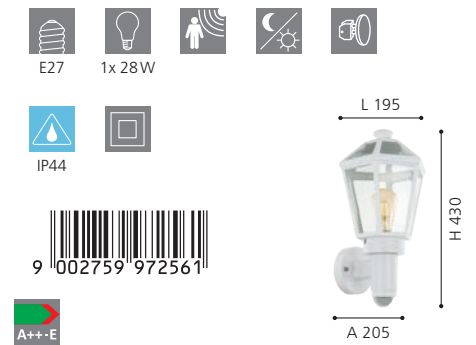



93456 NAVEDO

wall light; cast aluminium, black, silver-patina / glass, clear
Wandleuchte; Aluguss, schwarz, silber-patina / Glas, klar
applique; fonte d'aluminium, noir, argent patiné / verre, clair

L 200, H 475, A 285



93457 NAVEDO

wall light; cast aluminium, black, silver-patina / glass, clear
Wandleuchte; Aluguss, schwarz, silber-patina / Glas, klar
applique; fonte d'aluminium, noir, argent patiné / verre, clair

L 200, H 475, A 285



93458 NAVEDO

wall light; cast aluminium, black, silver-patina / glass, clear
Wandleuchte; Aluguss, schwarz, silber-patina / Glas, klar
applique; fonte d'aluminium, noir, argent patiné / verre, clair

L 200, H 425, A 285



SAFETY & COMFORT

110°, 7 m
5 sec. - 5 min.



93459 NAVEDO

wall light; cast aluminium, black, silver-patina / glass, clear
Wandleuchte; Aluguss, schwarz, silber-patina / Glas, klar
applique; fonte d'aluminium, noir, argent patiné / verre, clair

L 290, H 430, A 130



93462 NAVEDO

pedestal light; cast aluminium, black, silver-patina / glass, clear
Sockelleuchte; Aluguss, schwarz, silber-patina / Glas, klar
luminaire pour socle; fonte d'aluminium, noir, argent patiné / verre, clair

H 470, Ø 230, Base: Ø 170



93455 NAVEDO

pendant light; cast aluminium, black, silver-patina / glass, clear
Hängeleuchte; Aluguss, schwarz, silber-patina / Glas, klar
luminaire en suspension; fonte d'aluminium, noir, argent patiné / verre, clair

H 1045, Ø 230





93457





93465 NAVEDO

floor light; cast aluminium, black, silver-patina / glass, clear
 Stehleuchte; Aluguss, schwarz, silber-patina / Glas, klar
 lampadaire; fonte d'aluminium, noir, argent patiné / verre, clair

H 2200, Ø 560, Base: Ø 230

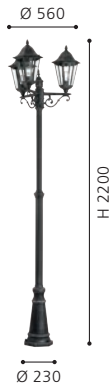

93464 NAVEDO

floor light; cast aluminium, black, silver-patina / glass, clear
 Stehleuchte; Aluguss, schwarz, silber-patina / Glas, klar
 lampadaire; fonte d'aluminium, noir, argent patiné / verre, clair

H 2000, Ø 230, Base: Ø 245



93463 NAVEDO

floor light; cast aluminium, black, silver-patina / glass, clear
 Stehleuchte; Aluguss, schwarz, silber-patina / Glas, klar
 lampadaire; fonte d'aluminium, noir, argent patiné / verre, clair

H 1200, Ø 230, Base: Ø 170



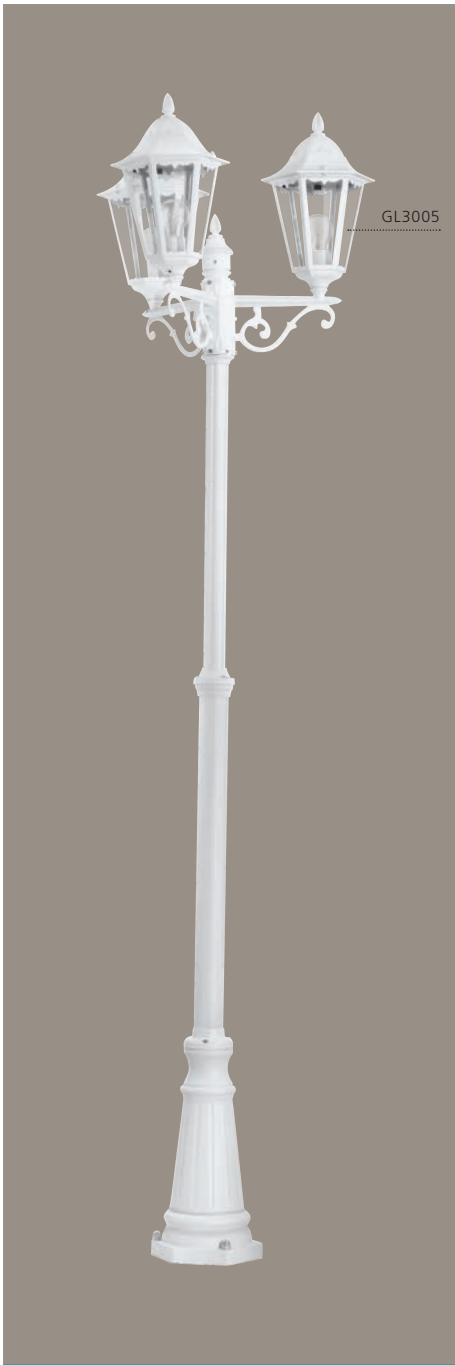

93454 NAVEDO

floor light; cast aluminium, white / glass, clear
 Stehleuchte; Aluguss, weiss / Glas, klar
 lampadaire; fonte d'aluminium, blanc / verre, clair

H 2200, Ø 560, Base: Ø 230

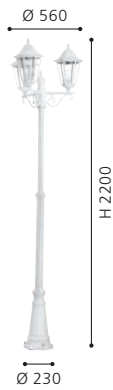

93453 NAVEDO

floor light; cast aluminium, white / glass, clear
 Stehleuchte; Aluguss, weiss / Glas, klar
 lampadaire; fonte d'aluminium, blanc / verre, clair

H 2000, Ø 230, Base: Ø 245

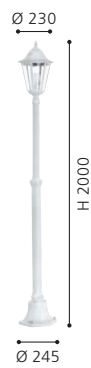

93452 NAVEDO

floor light; cast aluminium, white / glass, clear
 Stehleuchte; Aluguss, weiss / Glas, klar
 lampadaire; fonte d'aluminium, blanc / verre, clair

H 1200, Ø 230, Base: Ø 170

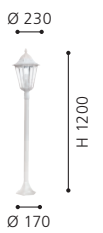



93445 NAVEDO

wall light; cast aluminium, white / glass, clear
 Wandleuchte; Aluguss, weiss / Glas, klar
 applique; fonte d'aluminium, blanc / verre, clair

L 200, H 475, A 285



93446 NAVEDO

wall light; cast aluminium, white / glass, clear
 Wandleuchte; Aluguss, weiss / Glas, klar
 applique; fonte d'aluminium, blanc / verre, clair

L 200, H 475, A 285



93447 NAVEDO

wall light; cast aluminium, white / glass, clear
 Wandleuchte; Aluguss, weiss / Glas, klar
 applique; fonte d'aluminium, blanc / verre, clair

L 200, H 425, A 285



SAFETY & COMFORT

110°, 7 m
 5 sec. - 5 min.



93448 NAVEDO

wall light; cast aluminium, white / glass, clear
 Wandleuchte; Aluguss, weiss / Glas, klar
 applique; fonte d'aluminium, blanc / verre, clair

L 290, H 430, A 130



93451 NAVEDO

pedestal light; cast aluminium, white / glass, clear
 Sockelleuchte; Aluguss, weiss / Glas, klar
 luminaire pour socle; fonte d'aluminium, blanc / verre, clair

H 470, Ø 230, Base: Ø 170





93445



22471 LATERNA 4

pendant light; cast aluminium, black / glass, clear
 Hängeleuchte; Aluguss, schwarz / Glas, klar
 luminaire en suspension; fonte d'aluminium, noir / verre, clair

H 900, Ø 205



E27 1x 60W IP44



9 002759 224714



22145 LATERNA 4

floor light; cast aluminium, black / glass, clear
 Stehleuchte; Aluguss, schwarz / Glas, klar
 lampadaire; fonte d'aluminium, noir / verre, clair

H 1920, Ø 550, Base: Ø 260



E27 3x 60W IP44



9 002759 221454



22144 LATERNA 4

floor light; cast aluminium, black / glass, clear
 Stehleuchte; Aluguss, schwarz / Glas, klar
 lampadaire; fonte d'aluminium, noir / verre, clair

H 1000, Ø 205, Base: Ø 170



E27 1x 60W IP44



9 002759 221447

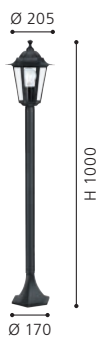



22467 LATERNA 4

wall light; cast aluminium, black / glass, clear
Wandleuchte; Aluguss, schwarz / Glas, klar
applique; fonte d'aluminium, noir / verre, clair

L 165, H 350, A 210



22468 LATERNA 4

wall light; cast aluminium, black / glass, clear
Wandleuchte; Aluguss, schwarz / Glas, klar
applique; fonte d'aluminium, noir / verre, clair

L 165, H 320, A 230



22469 LATERNA 4

wall light; cast aluminium, black / glass, clear
Wandleuchte; Aluguss, schwarz / Glas, klar
applique; fonte d'aluminium, noir / verre, clair

L 165, H 360, A 215



SAFETY & COMFORT

120°, 8 m
5 sec. - 9 min.



22472 LATERNA 4

pedestal light; cast aluminium, black / glass, clear
Sockelleuchte; Aluguss, schwarz / Glas, klar
luminaire pour socle; fonte d'aluminium, noir / verre, clair

H 385, Ø 195, Base: Ø 170

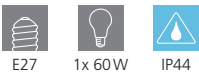

22467



22996 LATERNA 5

floor light; cast aluminium, white / glass, clear
 Stehleuchte; Aluguss, weiss / Glas, klar
 lampadaire; fonte d'aluminium, blanc / verre, clair

H 1920, Ø 535, Base: Ø 260

E27
 3x 60W
 IP44

9 002759 229962



22995 LATERNA 5

floor light; cast aluminium, white / glass, clear
 Stehleuchte; Aluguss, weiss / Glas, klar
 lampadaire; fonte d'aluminium, blanc / verre, clair

H 1030, Ø 195, Base: Ø 170

E27
 1x 60W
 IP44

9 002759 229955



22462 LATERNA 5

wall light; cast aluminium, white / glass, clear
 Wandleuchte; Aluguss, weiss / Glas, klar
 applique; fonte d'aluminium, blanc / verre, clair

L 165, H 350, A 210

E27
 1x 60W
 IP44

9 002759 224622



22463 LATERNA 5

wall light; cast aluminium, white / glass, clear
 Wandleuchte; Aluguss, weiss / Glas, klar
 applique; fonte d'aluminium, blanc / verre, clair

L 165, H 320, A 230

E27
 1x 60W
 IP44

9 002759 224639



SAFETY & COMFORT

22464 LATERNA 5

wall light; cast aluminium, white / glass, clear
 Wandleuchte; Aluguss, weiss / Glas, klar
 applique; fonte d'aluminium, blanc / verre, clair

L 165, H 360, A 215



9 002759 224646



22466 LATERNA 5

pedestal light; cast aluminium, white / glass, clear
 Sockelleuchte; Aluguss, weiss / Glas, klar
 luminaire pour socle; fonte d'aluminium, blanc / verre, clair

H 385, Ø 195, Base: Ø 170



9 002759 224660



22462

SPOTS, RECESSED & ACCESSOIRES

SPOTS, EINBAULEUCHTEN & ZUBEHÖR

SPOTS, LUMINAIRES ENCASTRÉS & ACCESSOIRES

HIGHLIGHTS FOR

OUTDOORS - Any outdoor area can be skilfully presented with spots, fitted lamps and the associated accessories. Stairwells, paths or the favourite spot in your garden will become a highlight this way.

HIGHLIGHTS FÜR DRAUSSEN - Mit Spots, Einbauleuchten und den dazugehörigen Accessoires lässt sich jeder Außenbereich gekonnt in Szene setzen. Treppenaufgänge, Wege oder der Lieblingsplatz im Garten werden so zum Highlight.



POINTS FORTS POUR

L'EXTÉRIEUR - Des spots, les luminaires encastrables et les accessoires associés mettent en scène avec savoir tout espace extérieur. Les accès à des escaliers, les chemins ou bien votre emplacement préféré deviennent ainsi le centre des attentions.



OVERVIEW

SPOTS, RECESSED & ACCESSOIRES





PAGINO
164



PAGINO
164



CASABAS
164



LAMOZZO
166



LAMOZZO 1
166



PALIZZI
168



PASTION
168



CASABAS
168



LUNANO
170



LM_LED_E27
171



DETECT ME 5
171



DETECT ME 6
172



DETECT ME 3
172



DETECT ME 4
172



DETECT ME 1
173



NEMA 1
174



NEMA 1
174



NEMA
174



FAEDO 4
174



PIERA 2
175



SPINETOLI
175



FAEDO 4
175



FAEDO 3
176



FAEDO 3
178



FAEDO 3
180



FAEDO 3
181



LAMEDO
182



TRONTO
182



RIGA 3
183



ZIMBA
184



ZIMBA
184

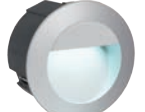

ZIMBA-LED
184



ZIMBA-LED
184



MARGO
185



PINEDA-IP
185



PARK 4
186



CONNECTOR BOX
186



188



CUBA
188



98175 PAGINO

wall light; plastic, white
Wandleuchte; Kunststoff, weiss
applique; plastique, blanc

L 245, H 220, A 180

LED 2x 6W 1800lm
neutral WHITE
IP44

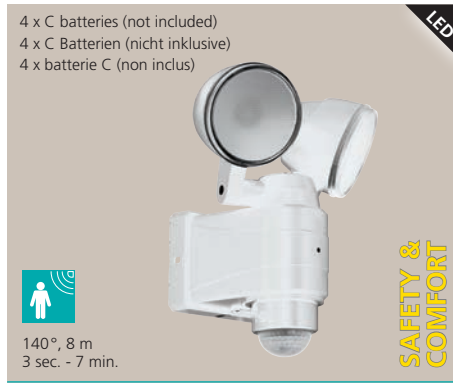
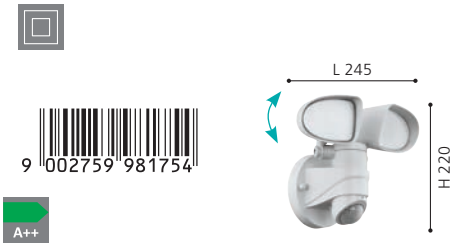

98194 CASABAS

wall light; plastic, white / plastic, satined
Wandleuchte; Kunststoff, weiss / Kunststoff, satiniert
applique; plastique, blanc / plastique, satiné

L 190, H 240, A 120

LED 2x 3,75W 800lm
cold WHITE
IP44

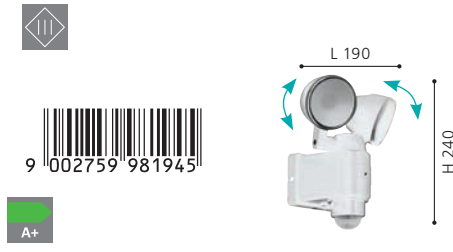

98177 PAGINO

wall light; plastic, white
Wandleuchte; Kunststoff, weiss
applique; plastique, blanc

L 180, H 260, A 160

LED 13W 2300lm
neutral WHITE
IP44

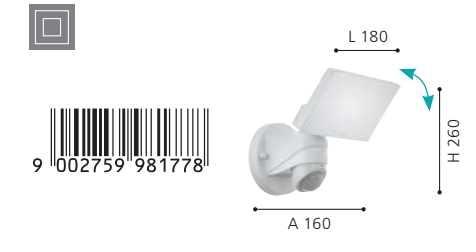

98176 PAGINO

wall light; plastic, black
Wandleuchte; Kunststoff, schwarz
applique; plastique, noir

L 245, H 220, A 180

LED 2x 6W 1800lm
neutral WHITE
IP44



98189 CASABAS

wall light; plastic, black / plastic, satined
Wandleuchte; Kunststoff, schwarz / Kunststoff, satiniert
applique; plastique, noir / plastique, satiné

L 190, H 240, A 120

LED 2x 3,75W 800lm
cold WHITE
IP44



98178 PAGINO

wall light; plastic, black
Wandleuchte; Kunststoff, schwarz
applique; plastique, noir

L 180, H 260, A 160

LED 13W 2300lm
neutral WHITE
IP44





98178



98757 LAMOZZO

wall light; plastic, white / plastic, transparent
 Wandleuchte; Kunststoff, weiss / Kunststoff, transparent
 applique; plastique, blanc / plastique, transparent

L 140, H 210, A 110

LED
 3,2W
 WW-NW
 440lm
 ACCU
 Li-ion
 2000mAh
 IP44

 9 002759 987572
 A+++ - A
 L 140, H 210, A 110



98758 LAMOZZO 1

wall light; plastic, black / plastic, transparent
 Wandleuchte; Kunststoff, schwarz / Kunststoff, transparent
 applique; plastique, noir / plastique, transparent

L 105, H 200, A 90

LED
 2W
 WW-NW
 264lm
 ACCU
 Li-ion
 1200mAh
 IP44

 9 002759 987589
 A+++ - A
 L 105, H 200, A 90

98757

Mode A: Automatically turns on at the dusk (< 30 lux) and remains 20% bright, up to 5 hours after which it turns off.

Mode B: Automatically turns on to full brightness (400 lm) when motion is detected in the range < 6 m and then turns to 3% brightness in 20 seconds if no motion.

Mode C: Automatically turns on to full brightness (400 lm) when motion is detected in the range < 6 m and then turns off in 30 seconds if no motion.

Mode A: Schaltet sich automatisch in den Dämmermodus (< 30 Lux) und bleibt bis zu 5 Stunden bei 20% der Helligkeit, bevor sie automatisch ausschaltet.

Mode B: Schaltet sich automatisch auf volle Helligkeit (400 lm), wenn eine Bewegung im Umkreis von 6 Metern erkannt wird, um nach 20 Sekunden ohne Bewegung auf 3% Helligkeit abzdimmten.

Mode C: Schaltet sich automatisch auf volle Helligkeit (400 lm), wenn eine Bewegung im Umkreis von 6 Metern erkannt wird, um nach 30 Sekunden ohne Bewegung abzuschalten.

Mode A: Allume automatiquement le crépuscule (< 30 lux) et conserve 20 % de luminosité, jusqu'à 5 heures, après lesquelles il s'éteint

Mode B: Allume automatiquement en pleine luminosité (400 lm) lorsqu'un mouvement est détecté au sein d'une portée de 6 mètres, puis passe à 3 % de luminosité, lors d'une absence de mouvement pendant 20 secondes.

Mode C: Allume automatiquement en pleine luminosité (400 lm) lorsqu'un mouvement est détecté au sein d'une portée de 6 mètres, puis s'éteint, lors d'une absence de mouvement pendant 30 secondes.

Front light/ vorne/ de face: **4000 K**
 Back light/ hinten/ retour: **3000 K**

*Front light/ vorne/ de face: **4000 K**
 *Back light/ hinten/ retour: **3000 K**

98758

	Battery above 30%		Battery below 30%	
	Front light*	Back light*	Front light	Back light
Motion detected	100 %	100 %	100 %	100 %
Motion out of range	weak	weak	off	weak

Automatically turns on to full brightness (400lm) when motion is detected in the range <6m and then turns to 3% brightness in 10 seconds if no motion is detected.

	Batterie über 30 %		Batterie unter 30 %	
	vorne	hinten	vorne	hinten
Bewegung erkannt	100 %	100 %	100 %	100 %
außerhalb Bereich	schwach	schwach	aus	schwach

Schaltet sich automatisch auf volle Helligkeit (400 lm), wenn eine Bewegung im Umkreis von 6 Metern erkannt wird, um nach 10 Sekunden ohne Bewegung auf 3% Helligkeit abzdimmten.

	Batterie de plus de 30 %		Batterie moins de 30 %	
	de face	retour	de face	retour
Mouvement détecté	100 %	100 %	100 %	100 %
hors de portée	faible	faible	éteint	faible

Allume automatiquement en pleine luminosité (400 lm) lorsqu'un mouvement est détecté au sein d'une portée de 6 mètres, puis passe à 3 % de luminosité, lors d'une absence de mouvement pendant 10 secondes.



98758



98195 CASABAS

wall light; plastic, black / plastic, white
Wandleuchte; Kunststoff, schwarz / Kunststoff, weiss
applique; plastique, noir / plastique, blanc

L 115, H 155, A 130

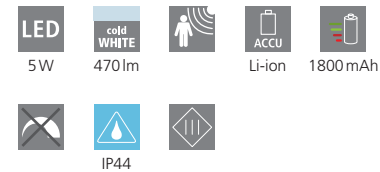

98196 CASABAS

wall light; plastic, white / plastic, white
Wandleuchte; Kunststoff, weiss / Kunststoff, weiss
applique; plastique, blanc / plastique, blanc

L 115, H 155, A 130

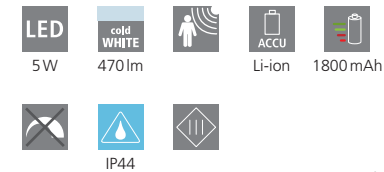

98187 PALIZZI

wall light; plastic, black / plastic, transparent
Wandleuchte; Kunststoff, schwarz / Kunststoff, transparent
applique; plastique, noir / plastique, transparent

L 155, H 145, A 110

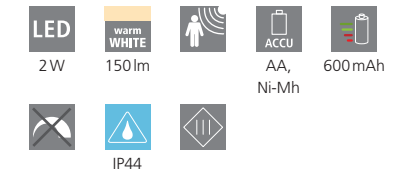

98196



98191 PASTION

wall light; plastic, black
Wandleuchte; Kunststoff, schwarz
applique; plastique, noir

L 180, H 120, A 130

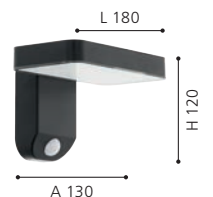



98191



97339 LUNANO

wall light; plastic, silver / plastic, white
 Wandleuchte; Kunststoff, silber / Kunststoff, weiss
 applique; plastique, argent / plastique, blanc

L 200, H 215, A 75

LED
 warm WHITE
 ACCU
 Li-ion
 2000mAh
 8h
 IP44

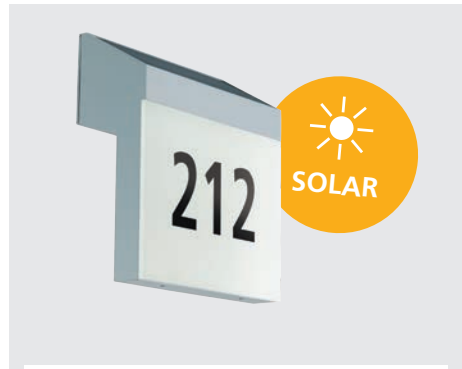

97339

Security and Comfort without electricity

This luminaire has a solar panel (full capacity with 6 h sun).
 No difficult cabling necessary, battery operated.
 2 operation modes:
ECO mode: 3lm / 40h bright life
Standard mode: 20lm / 8h bright life

Sicherheit und Komfort ohne Strom

Diese Leuchte hat ein Solarpanel (volle Kapazität nach 6 Sonnenstunden). Keine aufwändige Verkabelung notwendig, da batteriebetrieben.
 2 Einstellungsmodi:
ECO mode: 3lm / 40h Leuchtdauer
Standard mode: 20lm / 8h Leuchtdauer

Sécurité et confort sans électricité

Ce luminaire dispose d'un panneau solaire (pleine capacité avec 6 h de soleil). Pas de câblage difficile nécessaire, à la batterie.
 2 operation modes:
ECO mode: 3lm / 40h vie lumineuse
Standard mode: 20lm / 8h vie lumineuse



1x A-F 3x 0-9

97339

Letters and numbers included in delivery.

Buchstaben und Zahlen im Lieferumfang enthalten.

Les lettres et les nombres sont inclus dans la livraison.





SAFETY & COMFORT

97418 DETECT ME 5

motion detector; plastic, white
Bewegungsmelder; Kunststoff, weiss
détecteur de mouvement; plastique, blanc

L 65, H 95, A 35



IP44



9 002759 974183



SAFETY & COMFORT

11714 E27-LED-A60

illuminant; plastic, opal
Leuchtmittel; Kunststoff, opal
ampoule; plastique, opale

L 115, Ø 60



E27

1x 9,5W

3000K

25000h



220-240V, 15000x
50/60Hz

CRI >80

10



9 002759 117146



A+



9,5W

60W



11714

Security and Comfort for little money

This bulb has a Day & Night sensor and switches on automatically at dusk or off at dawn. Thanks to the E27 socket the bulb can easily be exchanged for existing luminaires. With an average electricity price of € 0,16/KWh and an average lighting time of 8 hours/day, the costs amount to approx. € 5,00 per year.

Sicherheit und Komfort für wenig Geld

Dieses Leuchtmittel verfügt über einen Day & Night-Sensor und schaltet sich selbständig bei Dunkelheit ein bzw. bei Helligkeit aus. Dank der E27-Fassung kann das Leuchtmittel einfach in bestehende Leuchten getauscht werden. Bei einem durchschnittlichen Strompreis von € 0,16/KWh und einer durchschnittlichen Leuchtdauer von 8 Stunden/Tag belaufen sich die Kosten auf ca. € 5,00 pro Jahr.

Sécurité et confort pour peu d'argent

Cette ampoule possède un capteur Day & Night et s'allume automatiquement au crépuscule ou à l'aube. Grâce à la prise E27, l'ampoule peut être facilement échangée. Avec un prix moyen de l'électricité de € 0,16 / KWh et un temps d'éclairage moyen de 8 heures / jour, les coûts s'élèvent à env. € 5,00 par an.



SAFETY & COMFORT

97419 DETECT ME 5

motion detector; plastic, black
Bewegungsmelder; Kunststoff, schwarz
détecteur de mouvement; plastique, noir

L 65, H 95, A 35



IP44



9 002759 974190



DETECT ME 5

Automatic illumination. This photo-electric lighting controller is used for controlling lighting systems for building fronts. It automatically switches light 'ON' at dusk automatically 'OFF' again at dawn. Of course, the light-level threshold at which the sensor responds and turns the light 'ON' is defined by no other than you yourself.

Automatische Beleuchtung. Der Day & Night Sensor dient zur Steuerung von Beleuchtungsanlagen an Hausfronten und schaltet bei Dämmerung automatisch das Licht AN und am Morgen automatisch wieder AUS. Die Dämmerungsschwelle, bei der der Sensor reagiert und die Beleuchtung schaltet, definieren Sie natürlich selbst.

Un éclairage automatique. Un éclairage automatique. L'interrupteur crépusculaire pour la commande des installations d'éclairage pour les façades de maison. Il allume automatiquement la lumière au crépuscule et l'éteint automatiquement à l'aube. C'est naturellement à vous de définir le seuil de luminosité auquel doit réagir le détecteur et allumer la lumière.



160°, 12 m
10 sec. - 15 min.

**SAFETY &
COMFORT**

97464 DETECT ME 3

motion detector; plastic, white
Bewegungsmelder; Kunststoff, weiss
détecteur de mouvement; plastique, blanc

L 100, H 100, A 55



IP44



9 002759 974640

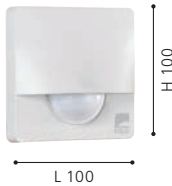

L 100



360°, 12 m
10 sec. - 15 min.

**SAFETY &
COMFORT**

97466 DETECT ME 4

motion detector; plastic, white
Bewegungsmelder; Kunststoff, weiss
détecteur de mouvement; plastique, blanc

L 70, H 55, A 100



IP44



9 002759 974664

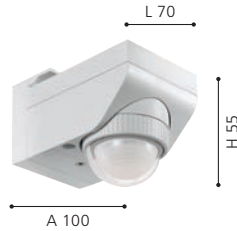

A 100



360°, 12 m
10 sec. - 15 min.

**SAFETY &
COMFORT**

97421 DETECT ME 6

motion detector; plastic, white / plastic, white
Bewegungsmelder; Kunststoff, weiss / Kunststoff, weiss
détecteur de mouvement; plastique, blanc / plastique, blanc

Ø 90, A 55



IP44



9 002759 974213

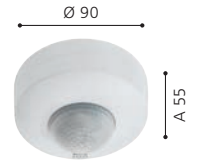

A 55



160°, 12 m
10 sec. - 15 min.

**SAFETY &
COMFORT**

97465 DETECT ME 3

motion detector; plastic, black
Bewegungsmelder; Kunststoff, schwarz
détecteur de mouvement; plastique, noir

L 100, H 100, A 55



IP44



9 002759 974657

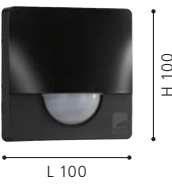

L 100



360°, 12 m
10 sec. - 15 min.

**SAFETY &
COMFORT**

97467 DETECT ME 4

motion detector; plastic, black
Bewegungsmelder; Kunststoff, schwarz
détecteur de mouvement; plastique, noir

L 70, H 55, A 100



IP44



9 002759 974671



A 100



360°, 12 m
10 sec. - 15 min.

**SAFETY &
COMFORT**

97422 DETECT ME 6

motion detector; plastic, black / plastic, white
Bewegungsmelder; Kunststoff, schwarz / Kunststoff, weiss
détecteur de mouvement; plastique, noir / plastique, blanc

Ø 90, A 55



IP44



9 002759 974220

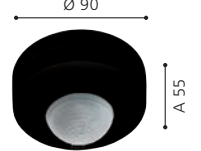

A 55



180°, 12 m
10 sec. - 15 min.

SAFETY & COMFORT

96452 DETECT ME 1

motion detector; plastic, white
Bewegungsmelder; Kunststoff, weiss
détecteur de mouvement; plastique, blanc

L 55, H 70, A 80



IP44



96452



DETECT ME 1

DETECT ME 3

DETECT ME 6

DETECT ME 4



MOUNT ON CEILING



MOUNT ON WALL

		•	•
•	•		•

Accessories incl. / Zubehör inkl. / Accessoires inclus



MOUNT IN CORNER



MOUNT ON CORNER

			
			included see page 172
10 sec. - 15 min.	10 sec. - 15 min.	10 sec. - 15 min.	10 sec. - 15 min.
12 m	12 m	12 m	12 m
180°	160°	360°	360°
+/- 40° horizontal 45° horizontal	+/- 30° horizontal +/- 90° vertical		
3 - 2000 lx	3 - 2000 lx	3 - 2000 lx	3 - 2000 lx
max. 800 W incandescent max. 400 W fluorescent	max. 1200 W incandescent max. 300 W fluorescent	max. 1200 W incandescent max. 300 W fluorescent	max. 1200 W incandescent max. 300 W fluorescent



180°, 12 m
10 sec. - 15 min.

SAFETY & COMFORT

96454 DETECT ME 1

motion detector; plastic, black
Bewegungsmelder; Kunststoff, schwarz
détecteur de mouvement; plastique, noir

L 55, H 70, A 80



IP44

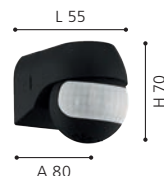

Ideal mounting height / Ideale Montagehöhe / Hauteur de montage ideale: ~ 2m



93384 NEMA 1

ground spike; plastic, black / plastic, transparent
 Erdspieß; Kunststoff, schwarz / Kunststoff, transparent
 piquet de terre; plastique, noir / plastique, transparent

L 115, B 60, H 185

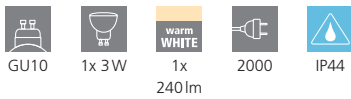

93385 NEMA 1

ground spike; plastic, black / plastic, transparent
 Erdspieß; Kunststoff, schwarz / Kunststoff, transparent
 piquet de terre; plastique, noir / plastique, transparent

L 115, B 115, H 180

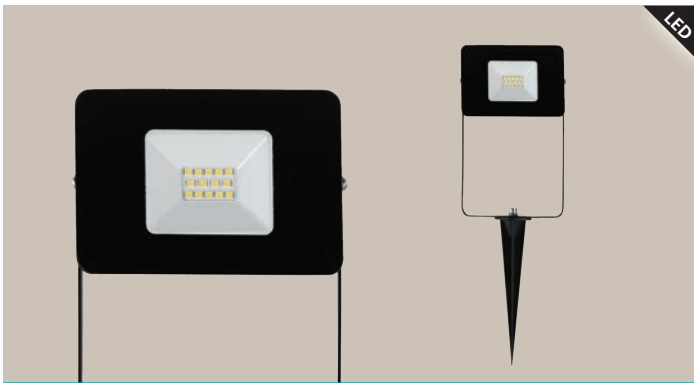
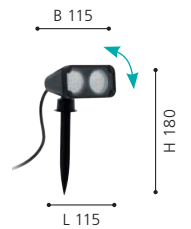
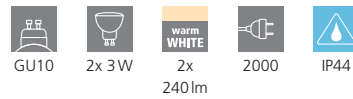

97471 FAEDO 4

ground spike; aluminium, black / glass, clear
 Erdspieß; Alu, schwarz / Glas, klar
 piquet de terre; aluminium, noir / verre, clair

L 115, B 35, H 310

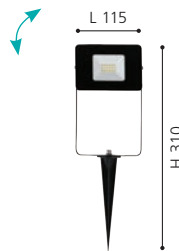

94111 NEMA

ground spike; stainless steel, stainless steel
 Erdspieß; Edelstahl, edelstahl
 piquet de terre; acier inoxydable, acier inoxydable

L 110, B 85, H 240, ET 165

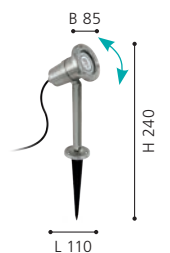
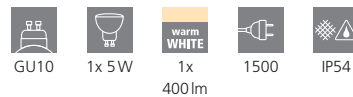

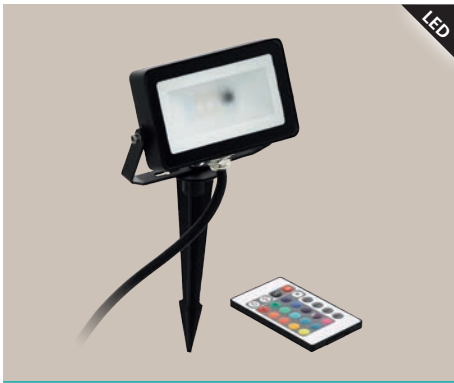

98185 FAEDO 4

flood light; aluminium, black / plastic, white
 Strahler; Alu, schwarz / Kunststoff, weiss
 projecteur; aluminium, noir / plastique, blanc

L 130, H 90, A 25

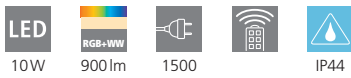

9 002759 981853



98183 PIERA 2

flood light; aluminium, plastic, silver, black / plastic, transparent
 Strahler; Alu, Kunststoff, silber, schwarz / Kunststoff, transparent
 projecteur; aluminium, plastique, argent, noir / plastique, transparent

L 165, B 105



9 002759 981839

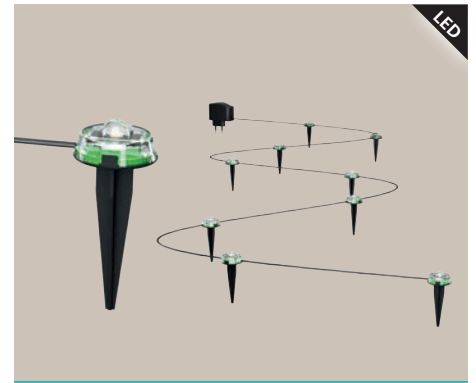

98184 SPINETOLI

ground spike; plastic, transparent / plastic, transparent
 Erdspieß; Kunststoff, transparent / Kunststoff, transparent
 piquet de terre; plastique, transparent / plastique, transparent

L 10000, B 30, H 10, ET 500



9 002759 981846

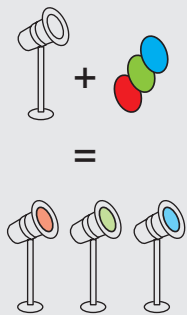

- GL2640 ● GL2642
- GL2641 ● GL2643

94111

NEMA comes with 3 different coloured bulb shades.

NEMA wird mit 3 verschiedenen farbigen Leuchtmittelabdeckungen ausgeliefert.

NEMA vient avec 3 couvercles d'ampoule en couleurs différentes.

94111





97459 FAEDO 3

wall light; aluminium, black / glass, clear
 Wandleuchte; Alu, schwarz / Glas, klar
 applique; aluminium, noir / verre, clair

L 110, H 135, A 50



10W 900lm



IP44



9 002759 974596



A+



97461 FAEDO 3

wall light; aluminium, black / glass, clear
 Wandleuchte; Alu, schwarz / Glas, klar
 applique; aluminium, noir / verre, clair

L 130, H 140, A 50



20W 1800lm



IP44



9 002759 974619



A+

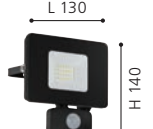

97462 FAEDO 3

wall light; aluminium, black / glass, clear
 Wandleuchte; Alu, schwarz / Glas, klar
 applique; aluminium, noir / verre, clair

L 175, H 190, A 50



30W 2750lm



IP44



9 002759 974626



A+

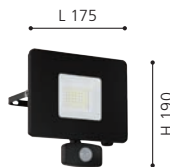

97463 FAEDO 3

wall light; aluminium, black / glass, clear
 Wandleuchte; Alu, schwarz / Glas, klar
 applique; aluminium, noir / verre, clair

L 205, H 200, A 50



50W 4800lm



IP44



9 002759 974633



A+





97463





LED

97455 FAEDO 3

wall light; aluminium, black / glass, clear
 Wandleuchte; Alu, schwarz / Glas, klar
 applique; aluminium, noir / verre, clair

L 110, H 80, A 30

LED 10W neutral WHITE IP65



9 002759 974558

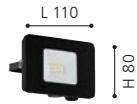

LED

97456 FAEDO 3

wall light; aluminium, black / glass, clear
 Wandleuchte; Alu, schwarz / Glas, klar
 applique; aluminium, noir / verre, clair

L 130, H 95, A 30

LED 20W neutral WHITE IP65



9 002759 974565

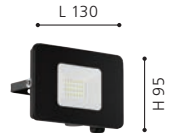

LED

97457 FAEDO 3

wall light; aluminium, black / glass, clear
 Wandleuchte; Alu, schwarz / Glas, klar
 applique; aluminium, noir / verre, clair

L 175, H 135, A 30

LED 30W neutral WHITE IP65



9 002759 974572



LED

97458 FAEDO 3

wall light; aluminium, black / glass, clear
 Wandleuchte; Alu, schwarz / Glas, klar
 applique; aluminium, noir / verre, clair

L 205, H 145, A 30

LED 50W neutral WHITE IP65



9 002759 974589





97458



LED

33152 FAEDO 3

wall light; aluminium, white / glass, clear
 Wandleuchte; Alu, weiss / Glas, klar
 applique; aluminium, blanc / verre, clair

L 110, H 80, A 30

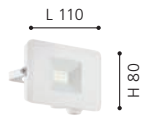

LED

33153 FAEDO 3

wall light; aluminium, white / glass, clear
 Wandleuchte; Alu, weiss / Glas, klar
 applique; aluminium, blanc / verre, clair

L 130, H 95, A 30

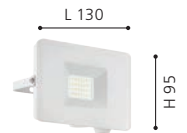

LED

33154 FAEDO 3

wall light; aluminium, white / glass, clear
 Wandleuchte; Alu, weiss / Glas, klar
 applique; aluminium, blanc / verre, clair

L 175, H 135, A 30

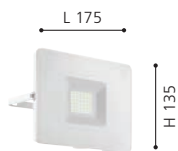

LED

33155 FAEDO 3

wall light; aluminium, white / glass, clear
 Wandleuchte; Alu, weiss / Glas, klar
 applique; aluminium, blanc / verre, clair

L 205, H 145, A 30





33156 FAEDO 3

wall light; aluminium, white / glass, clear
 Wandleuchte; Alu, weiss / Glas, klar
 applique; aluminium, blanc / verre, clair

L 110, H 135, A 50

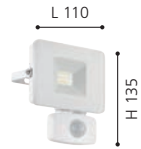

33157 FAEDO 3

wall light; aluminium, white / glass, clear
 Wandleuchte; Alu, weiss / Glas, klar
 applique; aluminium, blanc / verre, clair

L 130, H 140, A 50



33158 FAEDO 3

wall light; aluminium, white / glass, clear
 Wandleuchte; Alu, weiss / Glas, klar
 applique; aluminium, blanc / verre, clair

L 175, H 190, A 50

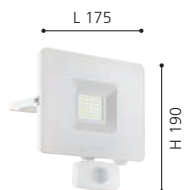

33159 FAEDO 3

wall light; aluminium, white / glass, clear
 Wandleuchte; Alu, weiss / Glas, klar
 applique; aluminium, blanc / verre, clair

L 205, H 200, A 50



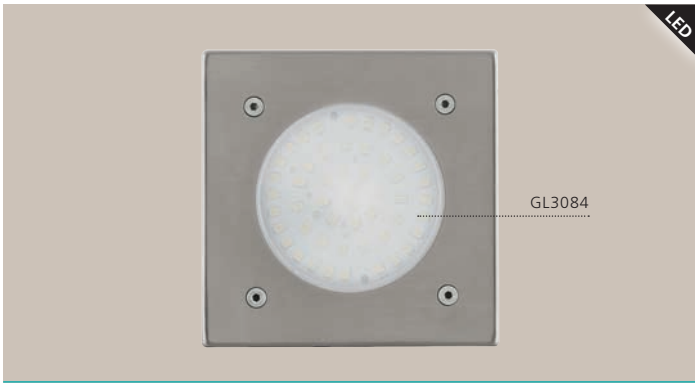

93481 LAMEDO

ground recessed light; stainless steel, stainless steel / satin glass, white
 Bodeneinbauleuchte; Edelstahl, edelstahl / Glas satiniert, weiss
 luminaire encastrable au; acier inoxydable, acier inoxydable / verre satiné, blanc

L 100, B 100, ET 65

LED
 1x 2,5W
 warm WHITE
 1x
 180lm
 IP65/67

 Ø 95

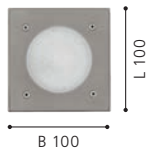

93482 LAMEDO

ground recessed light; stainless steel, stainless steel / satin glass, white
 Bodeneinbauleuchte; Edelstahl, edelstahl / Glas satiniert, weiss
 luminaire encastrable au; acier inoxydable, acier inoxydable / verre satiné, blanc

Ø 100, ET 65

LED
 1x 2,5W
 warm WHITE
 1x
 180lm
 IP65/67

 Ø 90



98182



98182 TRONTO

ground recessed light; stainless steel, plastic, stainless steel, black / plastic, transparent
 Bodeneinbauleuchte; Edelstahl, Kunststoff, edelstahl, schwarz / Kunststoff, transparent
 luminaire encastrable au; acier inoxydable, plastique, acier inoxydable, noir / plastique, transparent

H 2, Ø 45, ET 50

LED
 1W
 warm WHITE
 50lm
 IP65/67

 Ø 35



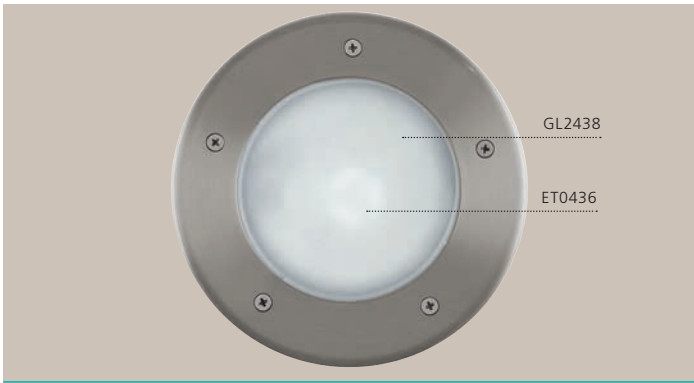

86189 RIGA 3

ground recessed light; stainless steel, stainless steel / plastic, white
 Bodeneinbauleuchte; Edelstahl, edelstahl / Kunststoff, weiss
 luminaire encastrable au; acier inoxydable, acier inoxydable / plastique, blanc

H 285, Ø 170



LAMEDO & RIGA 3 & TRONTO

No more annoying cables in your garden: bury them simply and safely with the CONNECTOR BOX.

Mit der CONNECTOR BOX können Sie störende Kabel einfach und sicher unter der Erde verschwinden lassen.

Tous les câbles incommodants disparaissent simplement et sûrement dans votre jardin avec CONNECTOR BOX.

see page 188
 siehe Seite 188
 voir page 188

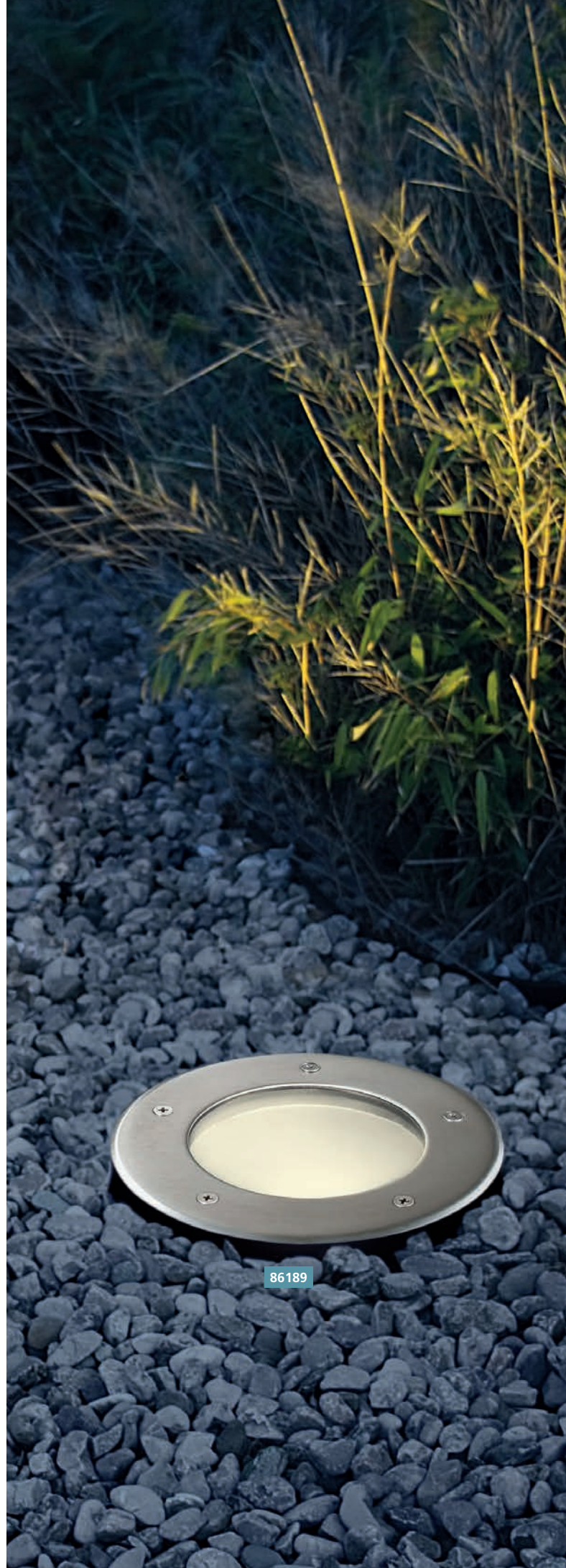

86189



GL1605

88008 ZIMBA

recessed light; cast aluminium, silver / satin glass, white
 Einbauleuchte; Aluguss, silber / Glas satiniert, weiss
 luminaire encastrable; fonte d'aluminium, argent / verre satiné, blanc

L 243, B 101, H 5, ET 100

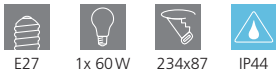

LED

95235 ZIMBA-LED

recessed light; cast aluminium, silver
 Einbauleuchte; Aluguss, silber
 luminaire encastrable; fonte d'aluminium, argent

L 140, B 140, H 5, ET 95

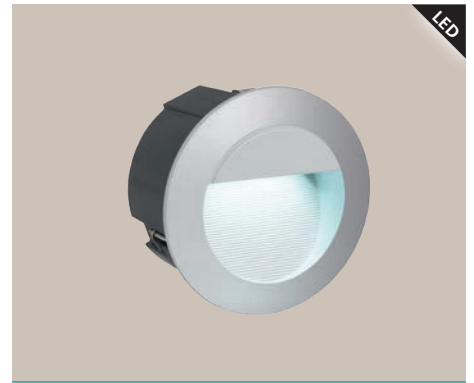
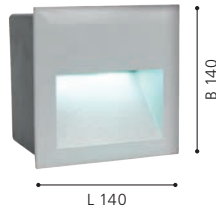

LED

95233 ZIMBA-LED

recessed light; cast aluminium, silver
 Einbauleuchte; Aluguss, silber
 luminaire encastrable; fonte d'aluminium, argent

H 5, Ø 125, ET 95

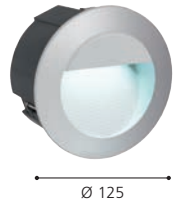

95235



88575 ZIMBA

recessed light; cast aluminium, silver / satin glass, white
 Einbauleuchte; Aluguss, silber / Glas satiniert, weiss
 luminaire encastrable; fonte d'aluminium, argent / verre satiné, blanc

L 227, B 127, H 13, ET 75

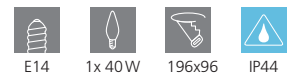



94093 MARGO

recessed light; cast aluminium, white / satin glass, white

Einbauleuchte; Aluguss, weiss / Glas satiniert, weiss

luminaire encastrable; fonte d'aluminium, blanc / verre satiné, blanc

H 10, Ø 84, ET 125



94092 MARGO

recessed light; cast aluminium, stainless steel / satin glass, white

Einbauleuchte; Aluguss, edelstahl / Glas satiniert, weiss

luminaire encastrable; fonte d'aluminium, acier inoxydable / verre satiné, blanc

H 10, Ø 84, ET 125



96415 PINEDA-IP

recessed light; plastic, satin nickel

Einbauleuchte; Kunststoff, nickel-matt

luminaire encastrable; plastique, nickel mat

Ø 78, ET 35



IP44/20

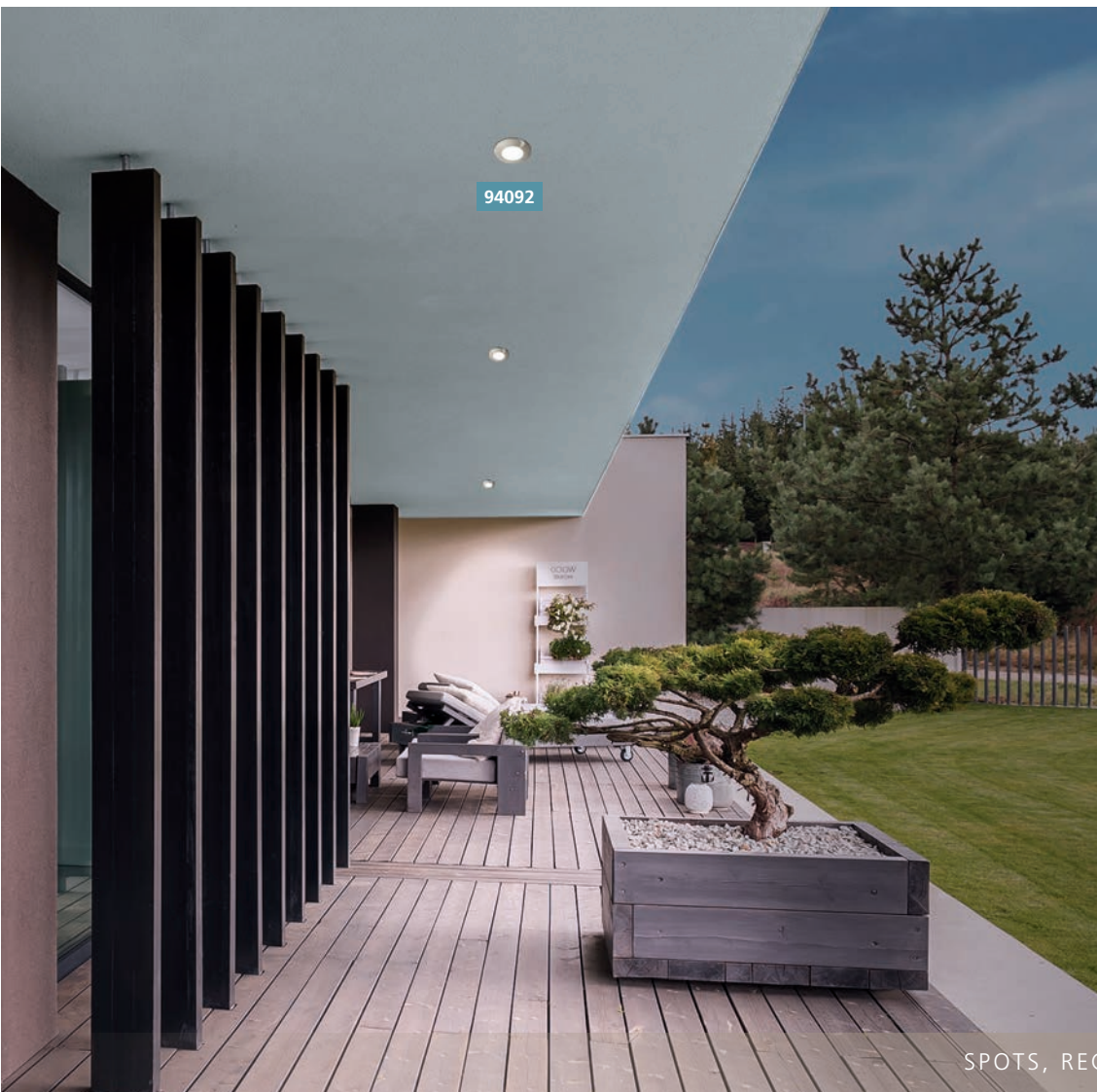

IP20

IP65 / IP44

PINEDA IP & MARGO

These luminaires are protected with IP65 / IP44 on the frontside and IP20 on the backside.

Diese Leuchten sind mit IP65 / IP44 frontseitig und IP20 rückseitig geschützt.

Disposent d'un degré de protection élevé IP65 / IP44 en face avant et IP20 en face arrière pour l'utilisation.



90748 PARK 4

accessory; stainless steel, stainless steel / plastic, green
 Zubehör; Edelstahl, edelstahl / Kunststoff, grün
 accessoire; acier inoxydable, acier inoxydable / plastique, vert

L 115, B 115, H 400, Base: B 160, T 160



IP44



9 002759 907488



93426 PARK 4

accessory; steel, plastic, black
 Zubehör; Stahl, Kunststoff, schwarz
 accessoire; acier, plastique, noir

L 115, B 115, H 400, Base: B 160, T 160



IP44



9 002759 934262



91206 CONNECTOR BOX

accessory; plastic, black
 Zubehör; Kunststoff, schwarz
 accessoire; plastique, noir

H 50, Ø 155



IP68



9 002759 912062



Ø 155



91207 CONNECTOR BOX

accessory; plastic, black
 Zubehör; Kunststoff, schwarz
 accessoire; plastique, noir

H 50, Ø 155



IP68



9 002759 912079



Ø 155



CONNECTOR BOX

No more annoying cables in your garden: bury them simply and safely with the CONNECTOR BOX.

91206: 1 supply line and 2 distribution lines

91207: 1 supply line and 5 distribution lines

Mit der CONNECTOR BOX können Sie störende Kabel einfach und sicher unter der Erde verschwinden lassen.

91206: 1 Zuleitung und 2 Verteilungsleitungen

91207: 1 Zuleitung und 5 Verteilungsleitungen

Tous les câbles inconfortables disparaissent simplement et sûrement dans votre jardin avec CONNECTOR BOX.

91206: 1 alimentation et 2 lignes de distribution

91207: 1 alimentation et 5 lignes de distribution

90748



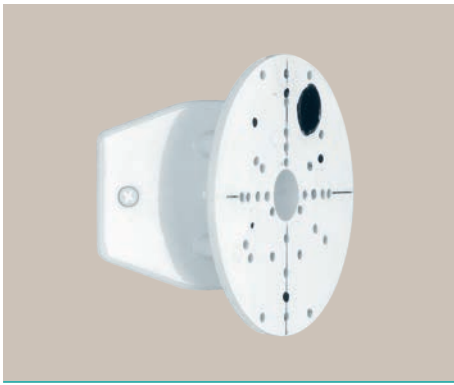

88152

accessory; steel, white
Zubehör; Stahl, weiss
accessoire; acier, blanc

H 50, Ø 112

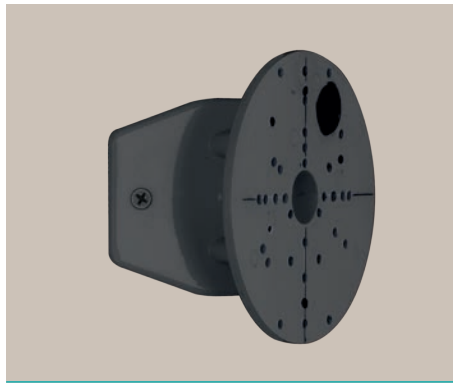

88153

accessory; steel, black
Zubehör; Stahl, schwarz
accessoire; acier, noir

H 50, Ø 112



88744 CUBA

ground spike; steel, zinc-plated
Erdspieß; Stahl, feuerverzinkt
piquet de terre; acier, galvanisé à chaud

H 300, Ø 185



8



9 002759 881528



Ø 112



9 002759 881535



Ø 112



9 002759 887445

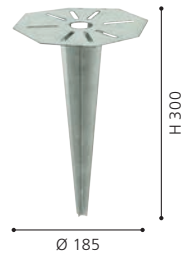

H 300

Ø 185

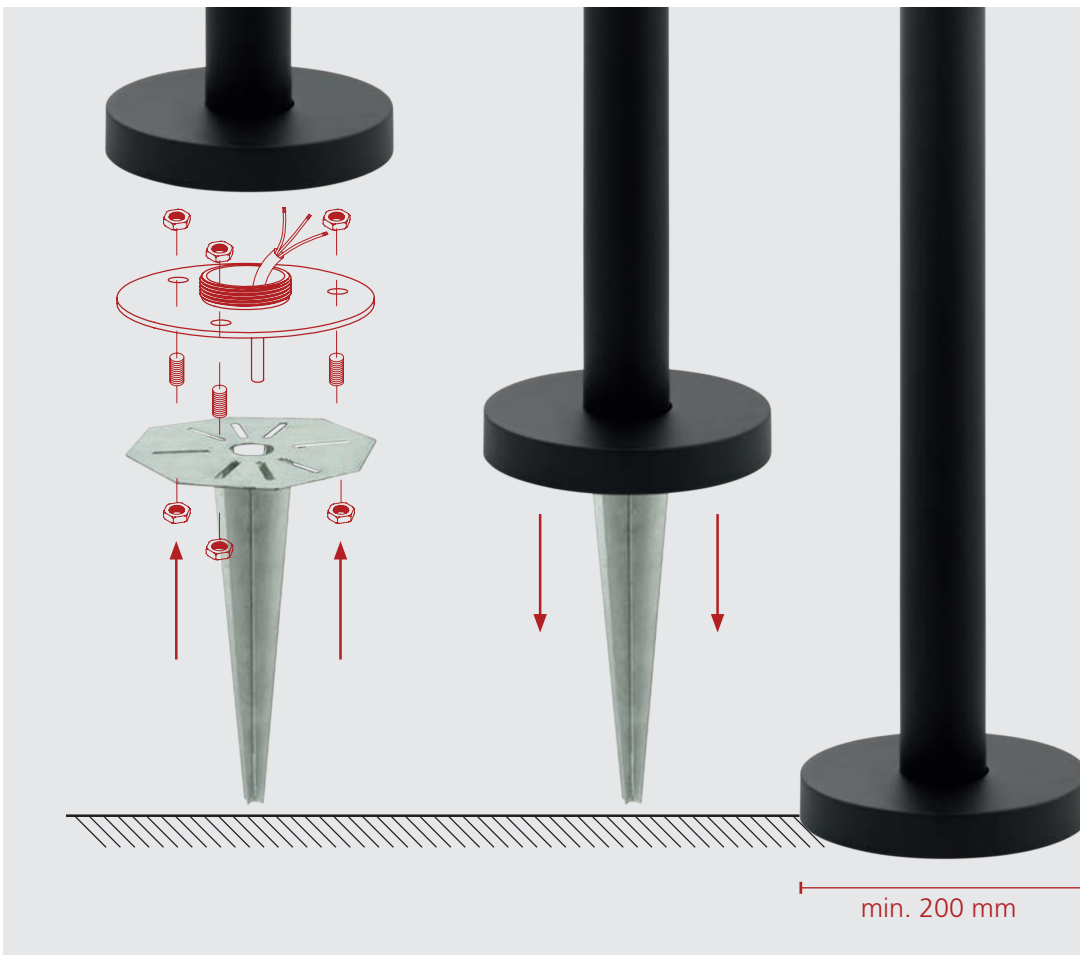

min. 200 mm

88744

With the CUBA ground spike you can stick your floor luminaire in the ground or set it in concrete.

Mit dem CUBA Erdspieß können Sie Ihre Stehleuchte in den Boden stecken oder einbetonieren.

Avec le piquet de terre CUBA vous pouvez fixer votre lampadaire en sol ou au béton.



88152



88152, 88153

The above mentioned pictogram indicates suitable luminaires which can be easily mounted on corners with this accessories.

Das oben gezeigte Piktogramm markiert passende Leuchten, welche mit dem Zubehör einfach an Ecken montiert werden können.

Le pictogramme ci-dessus marque les luminaires correspondant, qui peut être monté avec les accessoires simples dans les coins.

GARDEN LIVING



OVERVIEW

GARDEN LIVING



MONTEROLO
192



MONTEROLO
192



MONTEROLO
192



MONTEROLO
192

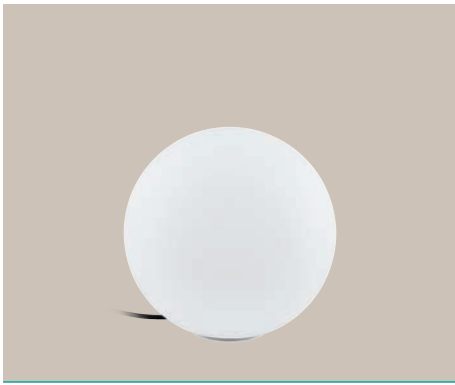

98101 MONTEROLO

floor light; plastic, white / plastic, white
Stehleuchte; Kunststoff, weiss / Kunststoff, weiss
lampadaire; plastique, blanc / plastique, blanc

H 300, Ø 300, Base: Ø 120

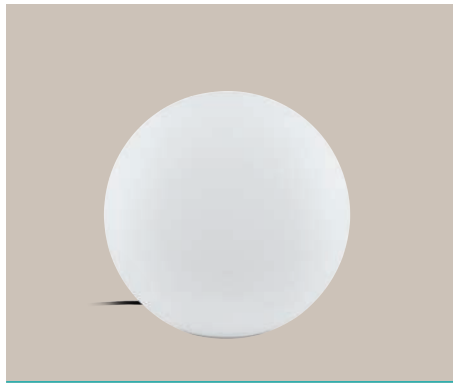

98102 MONTEROLO

floor light; plastic, white / plastic, white
Stehleuchte; Kunststoff, weiss / Kunststoff, weiss
lampadaire; plastique, blanc / plastique, blanc

H 390, Ø 390, Base: Ø 195

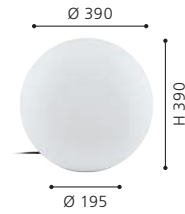

98103 MONTEROLO

floor light; plastic, white / plastic, white
Stehleuchte; Kunststoff, weiss / Kunststoff, weiss
lampadaire; plastique, blanc / plastique, blanc

H 500, Ø 500, Base: Ø 195

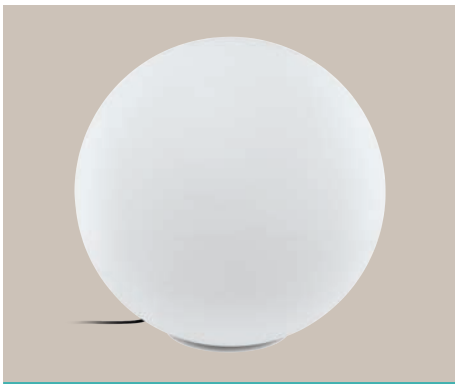
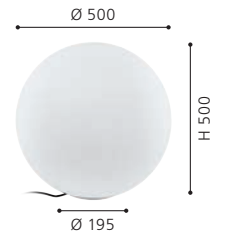

98104 MONTEROLO

floor light; plastic, white / plastic, white
Stehleuchte; Kunststoff, weiss / Kunststoff, weiss
lampadaire; plastique, blanc / plastique, blanc

H 600, Ø 600, Base: Ø 195

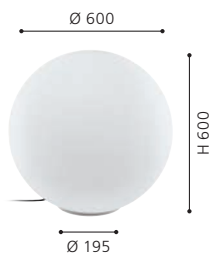



98102

98103

ENERGY EFFICIENCY LABELS

ENERGIEEFFIZIENZ-LABEL

LABEL DE L'EFFICACITÉ ÉNERGÉTIQUE

LED LUMINAIRES - are increasingly popular and the demand for energy-efficient solutions is gaining strength. This has resulted in the adoption of several EU regulations prescribing the energy efficiency labelling of light sources and luminaires. We have prepared a brief overview of the new energy labels.

LED LEUCHTMITTEL - sind am Vormarsch, der Ruf nach energieeffizienten Lösungen wird immer größer. In den letzten Jahren wurden daher mehrere EU-Verordnungen verabschiedet, die die Kennzeichnung der Energieeffizienz bei Leuchtmitteln und Leuchten vorschreibt. Hier finden Sie eine kurze Übersicht der neuen Energieeffizienzkenzeichnung.



LES ÉCLAIRAGES LED - gagnent du terrain, la demande de solutions efficaces en énergie ne cesse de croître. C'est la raison pour laquelle plusieurs directives européennes prescrivant le marquage de l'efficacité énergétique des moyens d'éclairage et des lampes ont été promulguées au cours de ces dernières années. Vous trouverez ici un bref aperçu d'ensemble des nouveaux marquages de l'efficacité énergétique.



The information in brackets at the centre of the label indicates which bulbs may be used for the luminaire. In this case, the product is only compatible with bulbs with an energy efficiency rating of better than C.

Die Klammer in der Mitte des Labels gibt an, mit welchen Leuchtmitteln die Leuchte kompatibel ist. In diesem Fall dürfen nur Leuchtmittel verwendet werden, deren Energieklasse effizienter als C ist.

La parenthèse au milieu du label indique les moyens d'éclairage avec lesquels la lampe est compatible. Il est seulement permis dans ce cas d'utiliser des moyens d'éclairage dont la classe d'énergie présente une efficacité supérieure à C.

If bulbs are included with the luminaire, their energy classes are indicated at the bottom of the label.

Falls Leuchtmittel inkludiert sind, wird deren Energieklasse im unteren Teil des Labels angegeben.

Si des moyens d'éclairage sont inclus, leur classe énergétique est indiquée dans la partie inférieure du label.



This label indicates that no bulbs are included with the luminaire. Consumers are free to choose their preferred bulb within the indicated energy classes.

Dieses Label wird verwendet, wenn die Leuchte ohne Leuchtmittel ausgeliefert wird. Der Kunde kann selber entscheiden, welches Leuchtmittel der angegebenen Klassen verwendet wird.

Ce label est utilisé lorsque la lampe est livrée sans ampoules. Le client peut décider lui-même quel ampoule des classes indiquées est utilisé.

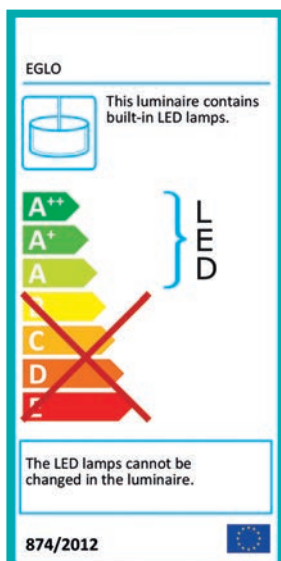

This label indicates that the luminaire is sold with built-in LED lamps that cannot be replaced by the consumer himself.

Dieses Label wird verwendet, wenn Leuchten mit LED-Modulen verkauft werden, die vom Endkunden nicht selbstständig ausgetauscht werden können.

Ce label est utilisé lorsque des lampes sont vendues avec des modules LED ne pouvant pas être changés par les clients finaux eux-mêmes.

EEL BUTTONS

bulbs included

inkl. Leuchtmittel | ampoules comprises



incl. highly efficient LED boards (cannot be replaced by the end consumer)

inkl. hocheffizienter LED Platinen (können nicht vom Endkonsumenten ausgetauscht werden)

incl. platines LED très efficaces (ne peuvent pas être remplacés par le consommateur final)



incl. highly efficient LED bulbs

inkl. hocheffizienter LED Leuchtmittel
ampoules à LED plus efficaces comprises



incl. efficient LED and/or fluorescent bulbs

inkl. effizienter LED und/oder Leuchtstoff-Leuchtmittel

ampoules à LED et/ou fluorescentes efficaces comprises



incl. halogen bulbs

inkl. Halogen-Leuchtmittel
ampoules halogènes comprises

bulbs not included

exkl. Leuchtmittel | ampoules non comprises



The luminaire is compatible with bulbs of all energy classes.

Die Leuchte ist mit Leuchtmitteln aller Energieklassen kompatibel.

compatible avec des ampoules de toutes les classes de l'énergie



The luminaire is only compatible with energy efficient bulbs.

Die Leuchte ist nur mit energieeffizienten Leuchtmitteln kompatibel.

compatible uniquement avec des ampoules économes en énergie

EGLO WORLDWIDE

EGLO WELTWEIT

EGLO DANS LE MONDE



 **HEADQUARTERS**
EGLO LEUCHTEN GMBH
Heiligkreuz 22
A-6136 PILL
T: +43 5242 6996 0 | F: +43 5242 6996 972
E: info-austria@eglo.com

 **CANADA**
EGLO CANADA INC.
20700 Route Transcanadienne
Baie-D'Urfé, Québec | H9X 4B7
T: +1 514 457 5483 | F: +1 514 457 5487
E: info-canada@eglo.com

 **CZECH REPUBLIC**
EGLO CZ+SK s.r.o.
Náchodská 2479/63
CZ-193 00 PRAHA 9 Horní Počernice
T: +420 281 924 163 | F: +420 281 925 205
E: info-czechrepublic@eglo.com

 **AUSTRALIA**
EGLO LIGHTING AUSTRALIA
5/339 Road
Richlands | Queensland 4077
T: +61 7 3375 1413 | F: +61 7 3375 1412
E: info-australia@eglo.com

 **CHILE - SANTIAGO**
EGLO CHILE ILUMINACION LTDA.
Av. Américo Vespucio 1930
Conchalí - SANTIAGO DE CHILE
T: +562 2 595 2222
E: info-chile@eglo.com

 **DENMARK**
EGLO DANMARK A/S
Agerbakken 20
DK-8362 Høring
T: +45 70 22 55 11 | F: +45 70 22 55 21
E: info-denmark@eglo.com

 **BELGIUM**
EGLO BELGIUM B.V.B.A.
Antwerpsesteenweg 247 | B-2950 Kapellen
Visit Address: Innovatiepark 20 |
4906 AA OOSTERHOUT (NL)
T: +32 3 250 60 80 | F: +32 3 219 80 67
E: info-belgium@eglo.com

 **CHINA**
DONGGUAN EGLO LIGHTING COMMERCIAL CO LTD
No.1 | Shangqiao Industrial Road | Shangqiao,
Dongcheng District
DONGGUAN CITY, GUANZHOU PROVINCE | CHINA
T: +86 769 2203 3866 | F: +86 769 2203 6866
E: info-china@eglo.com

 **ESTONIA**
MOODNE VALGUSTUS AS
Rävala pst. 7
EE-10143 TALLINN
T: +372 667 6670 | F: +372 631 3195
E: info-global@eglo.com

 **BOSNIA-HERZEGOVINA**
EGLO RASVJETA BH D.O.O.
Ormanica bb
BIH-76250 GRADACAC
T: +387 35 86 85 00 | F: +387 35 82 44 41
E: Info-Bosnia-Herzegovina@eglo.com

 **COLOMBIA**
EGLO COLOMBIA AUTOPISTA
NORTE KM 19 LOTE 30
COSTADO ORIENTAL CHÍA / COLOMBIA
T: +57 (1) 744 23 39
E: contacto@eglo.com.co

 **FINLAND**
EGLO FINLAND OY
Malminraitti 17A
00700 Helsinki
T: +358 20 7649 820 | F: +358 20 7649 821
E:

 **BRAZIL**
EGLO DO BRASIL LUMINÁRIAS LTDA.
Villa Lobos Park | Av. Queiroz Filho, 1.700,
Torre D, Sala 1, Vila Hamburguesa - São Paulo - Brasil
CEP: 05319-000, T: +55 11 4193 6980
F: +55 11 2337-3921 | E: Info-Brazil@eglo.com

 **COSTA RICA**
EGLO Costa Rica, Centro Comercial Calle Real local #8
Guachipilín de Escazú de la sucursal del BAC
San Jose 800 metros al norte San Jose Costa Rica.
T: +506-2289-4690, +506-2100-6384
E: Info-CostaRica@eglo.com

 **FRANCE**
EGLO FRANCE LUMINAIRE SARL
Z.A. Jeune Bois | 2 Rue de la Martinique
F-68274 WITTENHEIM
T: +33 389 6250 30 | F: +33 389 6250 49
E: info-france@eglo.com

 **BULGARIA**
EGLO BULGARIA EOOD
Main Road 5th kilometer,
Building KACHIKA, 8000 BOURGAS, Bulgaria
T: +359 56 960 403 | F: +359 56 53 05 95
E: info-bulgaria@eglo.com

 **CROATIA**
EGLO RASVJETA D.O.O.
Josipa Loncara 3
HR-10000 ZAGREB
T: +385 1 379 40 62 | F: +385 1 379 41 04
E: info-croatia@eglo.com

 **GERMANY**
EGLO LEUCHTEN HANDELS GMBH
Kleinbahnstr. 35
D-59759 ARNSBERG
T: +49 2932 6269 0 | F: +49 2932 6269 39
E: info-germany@eglo.com



GREECE
EGLO HELLAS A.E.
 Sykias 2 and parodos dekeleias
 ACHARNAI, GR-13679
 T: +30 210 240 77 10 | F: +30 210 240 07 29
 E: info-greece@eglo.com



GREAT BRITAIN
EGLO UK LTD.
 Unit 12 Cirrus Park, Lower Farm Road, Moulton Park
 Industrial Estate, NORTHAMPTON NN3 6UR
 T: +44 1604 790 986 | F: +44 1604 670 282
 E: info-greatbritain@eglo.com



HUNGARY - PRODUCTION & LOGISTICS
EGLO MAGYARORSZAG KFT.
 Fő út. 155
 H-3060 PASZTO
 T: + 36 32 560 050 | F: +36 32 560 040
 E: info-hungary@eglo.com



INDIA
EGLO INDIA PRIVATE LIMITED
 A-307 Ansal Chamber-1, 3 Bhikaji Cama Place,
 New Delhi-110066
 T: +91 981 108 2205 | T: +91 999 961 0450
 E: info-india@eglo.com



ITALY
EGLO ITALIANA S.R.L.
 Via Giotto, 4
 I-31021 MOGLIANO VENETO (TV)
 T: +39 041 45 66 232/245/251 | F: +39 041 45 74 066/071
 E: info-italy@eglo.com



KAZAKHSTAN
EGLO KAZAKHSTAN LLP
 Al-Farabi ave 7, Nurly-Tau Business Center, bld. 5A,
 113, 050059, Almaty, Kazakhstan
 mobile: +7 701 031 00 00 | T: +7 727 293 25 20, 311 52 90(91)
 E: info-kazakhstan@eglo.com



KOSOVO
EGLO KOSOVO LLC
 Lugašit e qytetit pn
 20000 PRIZREN- KOSOVO
 T: +377 44 2166 87 | Shop: +381 29 2442 84
 E: info-kosovo@eglo.com



LITHUANIA
MOODNE VALGUSTUS AS
 Rāvala pst. 7
 EE-10143 TALLINN
 T: +370 652 49923 | T: +372 667 6670
 E: info-lithuania@eglo.com



MAGYARORSZÁG – ÉRTÉKESÍTÉS
EGLO LUX KFT.
 Fő út. 143/A
 H-2120 DUNAKESZI
 T: +36 27 341 353 | F: +36 27 341 409
 E: info-hungary@eglo.com



MALAYSIA
EGLO ASIA SDN BHD
 No. 13, Jalan Pelukis U1/46B, Temasya 18, Glenmarie,
 40150 Shah Alam, Selangor Darul Ehsan, Malaysia
 T: +6011 1050 2336 | F: +603 5567 9415
 E: info-malaysia@eglo.com



MEXICO
EGLO MÉXICO ILUMINACIÓN S DE RL DE CV
 Prolongación Avenida López Mateos Sur N°3561,
 Fraccionamiento Los Gavilanes.
 C.P. 45645, Tlajomulco de Zúñiga, Jalisco, México
 T: +52 33 3687 20 95 | E: info-mexico@eglo.com



MIDDLE EAST
EGLO LIGHTING MIDDLE EAST FZE
 P.O. BOX 262073, LOB 6, OFFICE G18
 JEBEL ALI, DUBAI, UAE
 T: +97 148810080 | F: +97 148810081
 E: info.me@eglo.com



MOROCCO
EGLO AFRICA
 219 Bd Med Zerktowni. Suite: 67
 20330 CASABLANCA | Morocco
 T: +212 522 988 025
 E: info.africa@eglo.com



THE NETHERLANDS
EGLO VERLICHTING NEDERLAND B.V.
 Innovatiepark 20
 4906 AA OOSTERHOUT (NBR)
 T: +31 162 48 28 30 | F: +31 162 48 28 40
 E: Info-Netherlands@eglo.com



NORWAY
ELEKTRO-ARMATUR a.s
 Bjørnerudveien 18
 N-1266 OSLO
 T: +47 2262 9000 | F: +47 2262 9040
 E: info-norway@eglo.com



PERU
EGLO Peru SAC
 Avda. Primavera N° 1419 Distrito de Santiago de Surco
 Provincia y Departamento de Lima.
 T: +51 1 633 0655
 E: info-peru@eglo.com



PHILIPPINES
EGLO Lighting Pilipinas Corp.
 4/F One E-Com Center Building, Ocean Drive, Mall
 of Asia Complex, Pasay City 1300 Philippines
 T: +63 2 737 9419
 E: info-global@eglo.com



POLAND
EGLO POLSKA SP. Z.O.O.
 Ul. Pulawska 479
 02-844 WARSZAWA
 T: +48 22 644 57 55 | F: +48 22 644 89 82
 E: info-poland@eglo.com



PORTUGAL
EGLO PORTUGAL ILUMINAÇÃO, LDA
 Rua Fonte Parada, 125
 PT-4595-434 SEROIA-PAÇOS DE FERREIRA
 T: +351 255 890 000 | F: +351 255 892 346
 E: info-portugal@eglo.com



ROMANIA
EGLO ROMANIA PRODEXIM SRL.
 Str. Atomistilor nr. 1D
 R-077125 MAGURELE - ILFOV - ROMANIA
 T: +40 314 250 902 | F: +40 314 250 899
 E: info-romania@eglo.com



RUSSIA
EGLO LIGHTING LLC
 Varshavskoe shosse 35 | Building 1
 RU-117105 | MOSCOW
 T: +7495 789 4311 | F: +7495 789 4312
 E: info-russia@eglo.com



SERBIA
EGLO RASVETA DOO
 Stefana Provočenanog 28
 11000 BEOGRAD | SRBIJA
 T: +381 11 3981 366 | F: +381 11 3981 389
 E: info-serbia@eglo.com



SLOVAKIA
EGLO CZ+SK s.r.o
 Náchodská 2479/63
 CZ-193 00 PRAHA 9 Horní Počernice
 T: +421 313 211 551 | F: +421 313 211 556
 E: info-slovakia@eglo.com



SLOVENIA
EGLO RASVJETA D.O.O.
 Josipa Lončara 3
 HR-10000 ZAGREB
 T: +386 158 093 18
 E: info-slovenia@eglo.com



SPAIN
EGLO ESPAÑA ILUMINACIÓN S.L.
 Avda. de Castilla 1 (Edif. Best Point) 2º-16A
 San Fernando de Henares, E-28830 MADRID
 T: +34 91 677 9044 | F: +34 91 677 0304
 E: info-spain@eglo.com



SWEDEN
EGLO SVERIGE AB
 Honungsgatan 3
 S-432 48 VARBERG
 T: +46 340 623 505 | F: +46 340 623 605
 E: info-sweden@eglo.com



SWITZERLAND
EGLO SCHWEIZ AG
 Seetalstraße 142
 CH-6032 EMMEN
 T: +41 41 268 69 59 | F: +41 41 268 69 58
 E: info-switzerland@eglo.com



THAILAND
EGLO Thailand
 759 NapLab Building 4th Fl. Room 405
 Soi Chulalongkorn 6 Bunthudthong Road
 Wangmai, Pathumwan, Bangkok 10330
 Thailand



TURKEY
Eglo Aydınlatma ithalat ihracat Ltd. Şti.
 Eyüp Sultan Mah. Sekmen Cad. No:18/2
 34855 SAMANDIRA, SANCaktepe / İSTANBUL
 T: +90 216 311 09 -02 / -03 / -04 | F: +90 216 311 09 -05
 E: info-turkey@eglo.com



USA
EGLO USA, INC.
 3640 Royal South Parkway
 ATLANTA, GEORGIA 30349
 T: +1 404 477 5601 | F: +1 404 393 7053
 E: info-usa@eglo.com



UKRAINE
EGLO UKRAINE LTD
 bulv. Vatslav Havel 6/7A
 UA-03680 KIEV
 T: +38 044 463 98 41 | F: +38 044 468 84 67
 E: info-ukraine@eglo.com

HOW TO READ

ERKLÄRUNG COMMENT LIRE

ARTICLE NUMBER
ARTIKELNUMMER
NUMÉRO D'ARTICLE

SERIES NAME
SERIENNAME
NOM DE LA SÉRIE

DESCRIPTION
BESCHREIBUNG
DESCRIPTION

The product description is composed as follows:
luminaire type; enclosure material, enclosure colour / glass or shade material, glass or shade colour

Die Produktbeschreibung setzt sich wie folgt zusammen:
Leuchtenart; Gehäusematerial, Gehäusefarbe / Schirm- bzw. Glasmaterial, Schirm- bzw. Glasfarbe

La description du produit est composée comme suit:
type de luminaire; matériel de boîtier, couleur de boîtier / matériel de verre ou abat-jour, couleur de verre ou abat-jour

BUTTONS
BUTTONS
BOUTTONS

LED Lightcolour | LED Lichtfarbe | couleur de LED

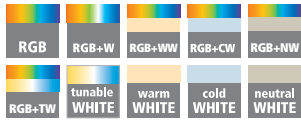

EEL bulbs not included | Leuchtmittel exklusive | ampoules non comprises



EEL bulbs included | Leuchtmittel inklusive | ampoules comprises

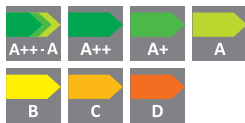

p.207

Colour Rendering Index | Farbwiedergabeindex | Indice de rendu de couleur de LED



Bulb included | Leuchtmittel inkludiert | ampoules inclus



Sensor included | Sensor inkludiert | Sensor inclus



DIMENSIONS
DIMENSIONEN
DIMENSIONS

all dimensions in mm | alle Größen in mm | toutes dimensions en mm

L = length | Länge | longueur

B = width | Breite | largeur

H = height | Höhe | hauteur

Ø = diameter | Durchmesser | diamètre

A = projection length | Ausladung | amplitude

ET = installation depth | Einbautiefe | profondeur utile

Base = base dimensions | Sockelmaße | dimensions de base

Attention! The dimensions relate solely to the sizes of the luminaire. Any air spaces that would be relevant for a safe operating of the lamp were not considered.

Achtung! Die Größen beziehen sich nur auf die Abmessungen der Leuchte. Etwaige Lufträume, die für einen sicheren Betrieb der Leuchte notwendig sind, werden nicht berücksichtigt.

Attention! Les dimensions se réfèrent à la taille de la lampe seulement. Espacements éventuels, que seraient importants pour une opération de la lampe sans danger, n'ont pas été considérés.

SPARE PARTS
ERSATZTEILE
PARTS DE REMPLACEMENT

If spare parts for product are available they are marked on the photograph with their corresponding article number.

Wenn zu einem Produkt Ersatzteile vorhanden sind, werden diese in der Abbildung mit der entsprechenden Artikelnummer markiert.

Si un produit a des parts de remplacement, elles sont marquées avec le numéro d'article dans la photo.

 <p>97238 VERRES wall light; stainless steel, plastic, stainless steel, white / plastic, white Wandleuchte; Edelstahl, Kunststoff, edelstahl, weiss / Kunststoff, weiss applique; acier inoxydable, plastique, acier inoxydable, blanc / plastique, blanc L 180, H 290, A 90</p> <p>E27 1x 12W IP44</p> <p>L 180 H 290 A 90</p> <p>9 002759 972387</p> <p>A++-B</p>	 <p>83433 PARK wall light; cast aluminium, anthracite / satin glass, white Wandleuchte; Aluguss, anthrazit / Glas satiniert, weiss applique; fonte d'aluminium, anthracite / verre satiné, blanc</p> <p>L 200, H 350, A 145</p> <p>E27 1x 60W IP44</p> <p>L 200 H 350 A 145</p> <p>9 002759 834333</p> <p>A++-E</p>	 <p>94138 BREGANZO wall light; zinc-plated steel, anthracite / plastic, white Wandleuchte; Stahl verzinkt, anthrazit / Kunststoff, weiss applique; acier galvanisé, anthracite / plastique, blanc</p> <p>L 180, H 250, A 115</p> <p>LED warm WHITE 2x 2,5W 2x 180lm IP44</p> <p>L 180 H 250 A 115</p> <p>9 002759 941383</p> <p>A+</p>
 <p>97218 MUSSOTTO wall light; stainless steel, plastic, stainless steel, white / plastic, white Wandleuchte; Edelstahl, Kunststoff, edelstahl, weiss / Kunststoff, weiss applique; acier inoxydable, plastique, acier inoxydable, blanc / plastique, blanc L 210, H 305, A 90</p> <p>E27 1x 28W IP44</p> <p>L 210 H 305 A 90</p> <p>9 002759 972189</p> <p>A++-E</p>	 <p>96018 BREGANZO 1 wall light; zinc-plated steel, anthracite / plastic, white Wandleuchte; Stahl verzinkt, anthrazit / Kunststoff, weiss applique; acier galvanisé, anthracite / plastique, blanc</p> <p>L 190, H 300, A 125</p> <p>LED warm WHITE 2x 2,5W 2x 180lm IP44</p> <p>L 190 H 300 A 125</p> <p>9 002759 960186</p> <p>A+</p>	 <p>96017 BREGANZO 1 wall light; zinc-plated steel, silver / plastic, white Wandleuchte; Stahl verzinkt, silber / Kunststoff, weiss applique; acier galvanisé, argent / plastique, blanc</p> <p>L 190, H 300, A 125</p> <p>LED warm WHITE 2x 2,5W 2x 180lm IP44</p> <p>L 190 H 300 A 125</p> <p>9 002759 960179</p> <p>A+</p>

96 | MODERN

PICTOGRAMMES
PIKTOGRAMME
PICTOGRAMMES

Technical details are represented as pictograms. An overview over all pictograms can be found on the next pages.

Technische Details werden als Piktogramme dargestellt. Eine Übersicht über alle Piktogramme finden Sie auf den nächsten Seiten.

Les détails techniques sont représentés sous forme de pictogrammes. Vous trouverez un aperçu de tous les pictogrammes dans les pages suivantes.

SKETCHES
SKIZZEN
CROQUIS

The sketches state the most meaningful dimensions. If a product is adjustable by will, a turquoise arrow marks this function and only the maximum dimensions are indicated.

Die Bemaßung der Skizzen umfasst jeweils die aussagekräftigsten Größen. Bei verstellbaren Produkten kennzeichnet ein türkiser Pfeil diese Funktion und nur die maximalen Größen werden angegeben.

Les dimensions des croquis comprennent les plus représentatives. Si un produit est réglable au choix, une flèche turquoise affiche cette fonction et rien que les dimensions maximales sont indiquées.



96017

PRODUCT IN THE AMBIANCE
PRODUKTE IM AMBIENTE
PRODUITS DANS L'AMBIENCE

You can find the article number next to each product in the ambiance pictures.

Sie finden die Artikelnummer neben jeder Abbildung des Produktes auf unseren Ambientebildern.

Vous pouvez trouver le numéro d'article à côté de chaque produit dans les images de l'ambiance.

SENSOR INCLUDED
SENSOR INKLUDIERT
SENSOR INCLUS

This symbol indicates luminaires with a sensor. In addition the Detection angle, Reach, Time setting (min./max.) and Response brightness (lx) is indicated.

Ist die Leuchte mit einem Sensor ausgestattet, wird dies durch ein Sensorsymbol gekennzeichnet. Zusätzlich werden Erfassungswinkel, Reichweite, Zeiteinstellung (max./min.) und die Ansprechhelligkeit (lx) angegeben.



















Un produit avec cette symbole ont une détecteur de mouvement. Aussi le angle de détection, la minuterie et Luminosité de déclenchement (lx) sont indiqué.

MODERN | 97





















































LEGEND

PICTOGRAM PIKTOGRAMME PICTOGRAMME

SOCKETS FASSUNGEN DOUILLES

 LED	 G4	 G53
 2G7	 G5	 GU5,3 / MR16
 2G11	 G9	 GU10
 2GX13	 G10Q	 GX53
 E14	 G13	 GY6,35
 E27	 G23	 R7s

BULBS LEUCHTMITTEL AMPOULES

 E14 / C35	 E27 / A60 Halogen	 E27 / E140 Filament
 E14 / C35f	 E27 / R63 Halogen	 E27 / PS160 Filament
 E14 / D45	 E27 / A60 LED	 E27 / T30 Filament
 E14 / C35f LED	 E27 / A60 Filament	 E27 / T32 Filament
 E14 / D45 Halogen	 E27 / A65 LED	 G4 / T9
 E14 / C35 Halogen	 E27 / A75 Filament	 G4 / LT9
 E14 / T22	 E27 / G45 LED	 G4 / LT14
 E14 / C35 Filament	 E27 / G45 Filament	 G9
 E14 / C37 Filament	 E27 / G80 Filament	 G9 LED
 E14 / C35f Filament	 E27 / G95	 GU10
 E14 / C37f Filament	 E27 / G95 Filament	 GU10 LED
 E14 / P45 LED	 E27 / G125	 GU10 SMD LED
 E14 / P45 Filament	 E27 / G95 LED	 GX53 / LF75
 E14 / P50	 E27 / G200 Filament	LED LED board / LED Platine / LED bord
 E14 / ST48 Filament	 E27 / R63 LED	 MR16
 E14 / ST64 Filament	 E27 / ST48 Filament	 MR16 LED
 E14 / T20 LED	 E27 / ST64 Filament	 R7s / 78mm
 E27 / A60	 E27 / B80 Filament	 R7s / 118mm
 E27 / G90	 E27 / BR150 Filament	 R7s / 78mm LED
 E27 / QR63	 E27 / DP165 Filament	 R7s / 118mm LED

LIGHT COLOUR & LUMEN
LICHTFARBE & LUMEN
COULEUR LUMINEUX & LUMEN

The colours of the LED are represented as pictogrammes (see below), their luminous flux directly beneath. The luminous flux is quoted in lumen and describes the amount of light generated by the LED. The higher the value, the brighter is the lamp. Lumens are LED boards and are the light measurement value in bulbs.

Die Farben der LED werden als Piktogramm (siehe unten) dargestellt, deren Lichtstrom direkt darunter. Der Lichtstrom wird in Lumen gemessen und gibt die erzeugte Lichtmenge der LED an. Je höher der Wert, desto heller das Produkt. Lichtstromangaben (Lumen) sind Platinen- bzw. Leuchtmittelwerte.

Les couleurs de LED ont représentés sous forme de pictogrammes, leur flux lumineux directement en dessous. L'unité de flux lumineux est le lumen et il mesure la quantité de lumière générée par les LED. Plus la valeur est élevée, plus la lampe est lumineuse. Les lumens sont l'unité de mesure de l'intensité lumineuse des ampoules et des panneaux led intégrés.

	RGB RGB RGB		RGB + tunabel white RGB + tunabel white RGB + tunabel white
	RGB + white RGB + weiß RGB + blanc		tunable white tunable white tunable white
	RGB + warmwhite RGB + warmweiß RGB + blanc chaud		warm white warmweiß blanc chaud
	RGB + coldwhite RGB + kaltweiß RGB + blanc froid		cold white kaltweiß blanc froid
	RGB + neutralwhite RGB + neutralweiß RGB + blanc neutral		neutral white neutralweiß blanc neutre

SWITCHES & SENSORES
SCHALTER & SENSOREN
INTERRUPTEUR & CAPTEURS

	incl. cable & plug inkl. Kabel & Stecker câble & connecteur inclus		pedal switch Trittschalter interrupteur à pied		swedish plug Stecker Schweden connecteur swede
	internal dimmer eingebauter Dimmer variateur intégré		cable switch Kabelschalter interrupteur à câble		"Touch me" ON/OFF "Touch me" EIN/AUS "Touch me" ON/OFF
	button switch Druckknopf interrupteur de pression		incl. cable & plug transformer inkl. Kabel & Stecktransformator câble & transformateur à prise		"Touch me" ON/OFF & dimm "Touch me" EIN/AUS & Dimmen "Touch me" ON/OFF & graduable
	function switch Funktionsschalter interrupteur fonction		remote control Fernbedienung télécommande		pull switch Zugschalter interrupteur à bascule
	rocker switch Wippschalter interrupteur à bascule		Day & Night Sensor Tag & Nacht Sensor sensor jour & nuit		Timer - automatic on/off Zeitschaltuhr - automatisches Ein- & Ausschalten minuterie - peut être éteint et allumé automatiquement
	pedal dimmer Trittdimmer variateur à pied		sensor Sensor sensor		

FUNKTIONEN & KOMFORT
FUNKTIONEN & KOMFORT
FONCTIONS & CONFORT

	incl. battery inkl. Akku incl. pile		cutout (in mm) Ausschnitt (in mm) perçage du panneau (en mm)		shortable kürzbar réductible
	incl. battery inkl. Batterie incl. pile		dimmmable dimmmbar graduabile		Voltage Volt Voltage
	battery specifications Batteriespezifikationen spécifications des piles		not dimmmable nicht dimmmbar ne pas graduabile		Watt
	beam angle Ausstrahlwinkel angle de rayonnement		replaceable LED austauschbare LED LED remplaçables		
	corner mount possible Eckmontage möglich montage en coin possible		loadable in kg belastbar in kg chargeable en kg		
	CRI Colour Rendering Index		packaging / delivery unit Verpackungs- / Liefereinheit unité d'emballage / de livraison		

PROTECTION CLASS
SCHUTZKLASSE
CLASSE DE PROTECTION

The protection class indicates to what extent the lamp is protected against electric shock. All lamps in this catalogue are at least protected with the protection class 1 - a higher class is specified in the information box of the respective lamp.

Die Schutzklasse gibt an, inwiefern ein Produkt gegen einen elektrischen Schlag gesichert ist. Alle Leuchten in diesem Katalog sind mit mindestens Schutzklasse 1 gesichert, bei höheren Klassen wird das Symbol im Infokasten der Leuchte angegeben.

La classe de protection indique, dans quelle mesure la lampe est protégée contre les chocs électriques. Tous les lampes dans ce catalogue sont protégées au moins avec la classe 1 - une classe plus élevée est indiquée dans l'information de la lampe.

	protection class 1: protective earthing Schutzklasse 1: Schutzerdung classe de protection 1: prise de terre		protection class 2: protective insulation Schutzklasse 2: Schutzisolation classe de protection 2: double isolation ou renforcée		protection class 3: protective low voltage Schutzklasse 3: Schutzkleinspannung classe de protection 3: très basse tension de sécurité
--	---	--	---	--	---

PROTECTION RATING
SCHUTZGRAD
INDICE DE PROTECTION

The protection rating ensures the operational safety of luminaires. The first number specifies the extent of the protection against the ingress of foreign bodies; the second number identifies the humidity protection grade. All luminaires in this catalogue are at least protected with the rating IP20 - a higher rating is specified in the information box of the luminaire.

Der Schutzgrad gewährleistet die Betriebssicherheit von Leuchten. Die erste Ziffer des IP Grades beschreibt den Schutzzumfang gegen das Eindringen von Fremdkörpern, die zweite Ziffer informiert über den Grad des Feuchtigkeitsschutzes. Alle Leuchten in diesem Katalog sind mit mindestens Schutzgrad IP20 gesichert, bei höheren Graden wird das Symbol im Infokasten der Leuchte angegeben.

L'indice de protection assure la sécurité opérationnelle des luminaires. Le premier chiffre indique à quel point la protection est efficace contre l'insertion de corps étrangers; le second chiffre indique quant à lui le degré de protection par rapport à l'humidité. Tous les luminaires dans ce catalogue sont protégés au moins avec l'indice IP20 - un indice plus élevé est indiqué dans l'information d'article.

	IP33		IP44		IP54		IP65		IP67
--	------	--	------	--	------	--	------	--	------

REGISTER

SERIES NAMES
SERIENNAMEN
NOME DE PRODUITS

name name nom	page seite page	name name nom	page seite page	name name nom	page seite page	name name nom	page seite page
ABRANTES	107	CITY	98	LAMOZZO	166	ONTANEDA	90
ACATE	74	CIVIDINO	123	LAMOZZO 1	166	PAGINO	164
ADAMELLO	70	COLINDRES	138	LATERNA 4	156	PALIZZI	168
AGOLADA	85	CONNECT REMOTE	14	LATERNA 5	158	PALOSCO	47
ALAMONTE	123	CONNECT SENSOR	14	LEPUS	100	PARK	96
ALAMONTE 1	125	CONNECTOR BOX	186	LISIO	131	PARK 4	186
ALBACETE	139	CORNALE	71	LM_LED_E27	18	PASSIRANO	65
ALBENZA	70	CUBA	188	LM_LED_GU10	23	PASTION	168
ALORIA	147	CULPINA	67	LOCANA-C	14	PERAFITA	77
AMAROSI	66	DARIL 1	82	LUNANO	170	PERNATE	64
ARGOLIS	90	DESELLA 1	111	MANERBIO	149	PIAS	74
ARGOLIS-C	15	DETECT ME 1	173	MANFRIA	42	PIERA 2	175
ATOLLARI	62	DETECT ME 3	172	MARCHESA	63	PILONE	91
AZZINANO	75	DETECT ME 4	172	MARCHESA-C	17	PINEDA-IP	185
BARROSELA	136	DETECT ME 5	171	MARGO	185	PIOVE-C	14
BASALGO 1	56	DETECT ME 6	172	MELGOA	136	POLIENTO	55
BELCREDA	108	DONATORI	52	MELZO	49	PRATA VECCHIA	53
BEVERLY	84	DONINNI 1	44	MERLITO	86	PREDAZZO	79
BEVERLY 1	114	EGLO CONNECT	13	MILTON	139	PULFERO	135
BOSARO	95	EMOLLIO	109	MIRANDOLA	122	PULFERO 1	135
BOVOLONE	137	ENTRIMO	101	MONGODIO	91	RALORA	75
BREGANZO	96	FAEDO 3	180	MONREALE	142	RALORA 1	75
BREGANZO 1	96	FAEDO 4	174	MONSELICE	149	RAVELLO	126
BRIANZA	46	FANTECOLO	83	MONTEROLO	192	REDONDO	78
BRIONES	114	FAVRIA 1	81	MONTEROLO-C	22	RIFORANO	38
CALDIERO	60	FIUMICINO	50	MONTEROS	69	RIGA	89
CALDIERO-C	19	FRANCARI	64	MORINO	78	RIGA 3	183
CALGARY 1	74	FRANCARI-C	17	MUSSOTTO	96	RIGA 5	88
CALPINO	110	GORZANO	78	NADELA	70	RIGA-LED	86
CANOVE	136	HELSINKI	58	NAVEDO	154	ROALES	112
CASABAS	164	HILBURN	132	NEMA	174	ROBLEDO	84
CASCINETTA	121	HILBURN 1	132	NEMA 1	174	SAKEDA	106
CERNO	98	INFESTO 1	73	NEMA 1-C	23	SALVANESCO	66
CHEIRA	114	IPHIAS	113	NEMBRO	40	SAN TELMO	139
CHINOA	65	JORBA	76	NISIA	54	SESIMBA	92
CICERONE	63	KIBEA	70	NISIA-C	20	SESIMBA 1	92
CISTIerna	80	LAGASCO	79	ONCALA	54	SEVILLA	101
CISTIerna 1	82	LAMEDO	182	ONJA	100	SIDNEY	130

name
name
nom

page
seite
page

SIRMIONE	128
SITIA	68
SONCINO	122
SONELLA	72
SOSSANO	148
SPINETOLI	175
STOCKHOLM 1	84
TABO	74
TONEGO	84
TORAZZA-C	16
TRECATE	137
TREVILO	94
TREVILO 1	94
TRIBANO	82
TRONO STICK	83
TRONTO	182
VALDEO	137
VENTO 1	91
VENTO 2	91
VERLUCCA	127
VERRES	96
VERRES-C	18
VILLAGRAZIA	120
ZIMBA	184
ZIMBA-LED	184



REGISTER

ARTICLE NUMBER
ARTIKELNUMMER
NUMÉROS D'ARTICLE

Number nummer Numéro	page seite page	Number nummer Numéro	page seite page	Number nummer Numéro	page seite page	Number nummer Numéro	page seite page	Number nummer Numéro	page seite page	Number nummer Numéro	page seite page	Number nummer Numéro	page seite page
11585	13	88119	101	93462	150	94863	138	97119	84	97453	60	98145	17
11586	23	88139	98	93463	152	94864	132	97146	60	97455	178	98147	63
11671	23	88142	98	93464	152	94865	132	97147	60	97456	178	98148	50
11684	18	88144	98	93465	152	94866	132	97153	148	97457	178	98149	50
11714	171	88152	188	93481	182	94867	132	97155	149	97458	178	98151	50
22144	156	88153	188	93482	182	94871	72	97159	75	97459	176	98152	50
22145	156	88489	101	93991	95	94872	72	97218	96	97461	176	98153	120
22462	158	88575	184	93994	79	94877	73	97219	16	97462	176	98154	120
22463	158	88744	188	94086	75	95016	55	97222	78	97463	176	98171	15
22464	159	89767	100	94092	185	95017	55	97226	136	97464	172	98172	15
22466	159	89768	100	94093	185	95076	107	97237	14	97465	172	98173	15
22467	157	90184	139	94099	89	95079	114	97238	96	97466	172	98174	15
22468	157	90748	186	94101	89	95097	111	97239	18	97467	172	98175	164
22469	157	90867	100	94102	89	95233	184	97241	110	97471	174	98176	164
22471	156	91206	186	94103	89	95235	184	97242	110	97475	14	98177	164
22472	157	91207	186	94105	89	95982	54	97244	127	97482	19	98178	164
22995	158	92736	86	94106	88	95987	68	97245	127	97483	19	98182	182
22996	158	93094	147	94107	88	95988	68	97247	20	97484	19	98183	175
27126	54	93095	147	94111	174	95989	75	97248	20	97485	19	98184	175
30184	131	93096	147	94114	74	96006	77	97249	20	97631	48	98185	175
30185	131	93097	145	94121	91	96007	77	97254	91	97632	48	98187	168
30187	131	93098	145	94127	83	96013	84	97256	149	97843	86	98189	164
30188	131	93099	145	94128	83	96017	96	97257	148	97844	86	98191	168
30191	98	93254	70	94138	96	96018	96	97258	149	98052	23	98194	164
30192	98	93268	84	94186	74	96019	92	97259	148	98085	80	98195	168
30205	54	93318	78	94277	56	96021	92	97261	137	98086	80	98196	168
30206	54	93319	78	94278	56	96022	92	97284	82	98087	67	98232	64
30207	54	93365	74	94279	56	96206	101	97285	128	98088	67	98233	64
32732	14	93368	78	94281	56	96207	136	97286	128	98091	66	98234	17
32898	88	93384	174	94779	95	96239	137	97287	128	98092	66	98266	44
32899	88	93385	174	94784	90	96241	139	97288	128	98095	42	98267	44
33152	180	93402	146	94785	90	96255	76	97289	71	98096	42	98268	44
33153	180	93403	147	94788	125	96256	76	97294	122	98097	42	98269	44
33154	180	93404	146	94789	124	96262	139	97295	14	98098	42	98271	44
33155	180	93405	146	94792	136	96274	109	97296	137	98101	192	98272	45
33156	181	93406	144	94796	92	96275	109	97297	114	98102	192	98273	124
33157	181	93407	145	94799	114	96276	62	97299	14	98103	192	98701	52
33158	181	93408	144	94803	85	96277	62	97301	49	98104	192	98702	52
33159	181	93409	144	94804	85	96282	112	97302	48	98105	22	98703	52
81751	58	93426	186	94805	136	96286	106	97303	49	98106	22	98704	66
81752	58	93438	70	94827	123	96287	106	97304	48	98107	22	98705	66
81753	59	93445	154	94831	124	96288	106	97307	64	98108	23	98706	94
82309	98	93446	154	94832	124	96365	91	97308	64	98115	142	98707	46
83278	59	93447	154	94833	124	96415	185	97311	108	98116	142	98708	46
83279	58	93448	154	94834	135	96452	173	97312	108	98117	142	98709	65
83281	58	93451	154	94838	138	96454	173	97313	81	98118	142	98711	65
83433	96	93452	153	94841	135	96488	113	97314	81	98119	140	98712	91
83589	139	93453	153	94842	132	96489	113	97339	170	98121	140	98713	121
83966	130	93454	153	94843	132	96491	90	97418	171	98122	140	98714	121
83971	130	93455	150	94845	74	96492	90	97419	171	98123	140	98715	121
86189	183	93456	150	94848	92	96494	72	97421	172	98127	63	98716	82
86541	84	93457	150	94854	135	96495	72	97422	172	98128	63	98717	70
87105	130	93458	150	94855	135	96504	87	97445	127	98143	69	98718	82
88008	184	93459	150	94858	138	96505	87	97451	60	98144	69	98719	122

Number
number
Numéro

page
seite
page

98721	126
98722	126
98723	126
98724	126
98725	38
98726	38
98727	38
98728	38
98729	65
98731	53
98732	53
98733	53
98736	79
98737	47
98738	47
98739	47
98741	83
98744	123
98745	70
98746	94
98747	94
98748	40
98749	40
98751	40
98757	166
98758	166

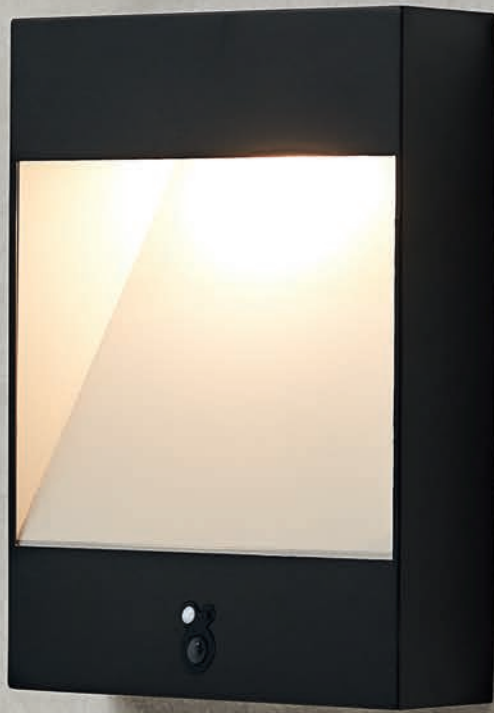

NOTES

NOTIZEN
NOTES

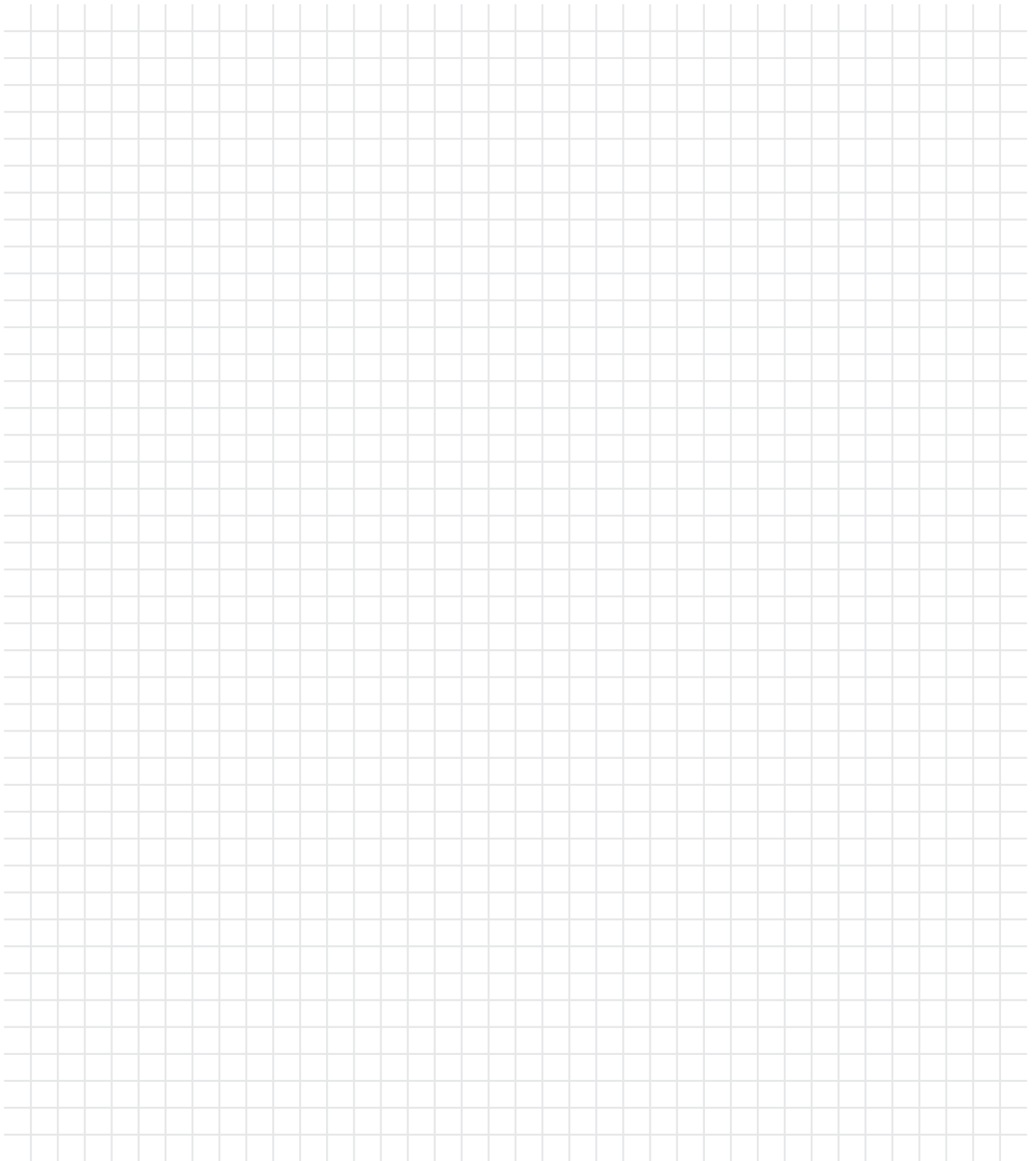

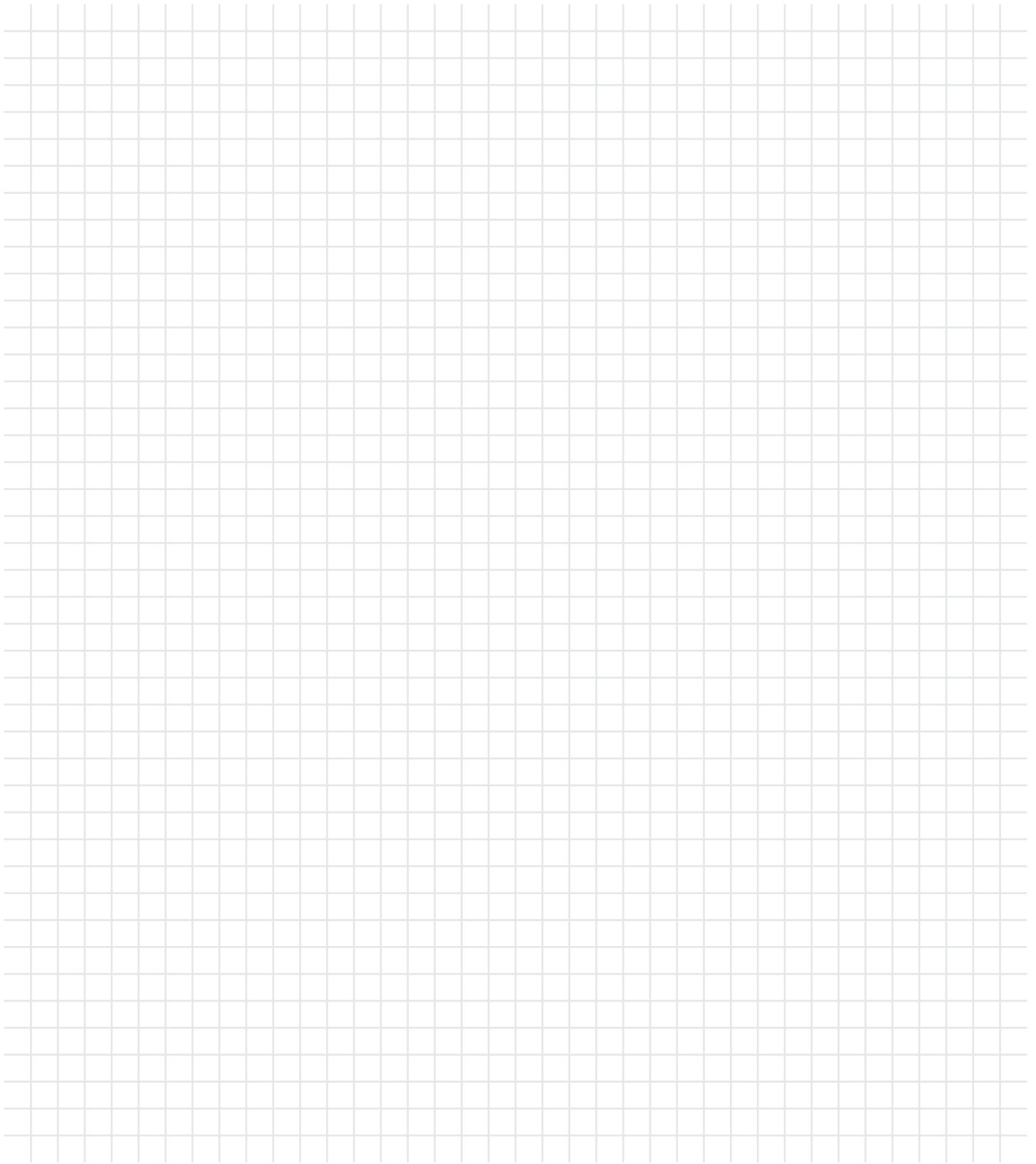

All previous catalogues and price lists are no longer valid with the issue of this catalogue. Errors, misprints, model and price changes and technical modifications are reserved. We deliver based on our terms of delivery and payment. Our products comply with the European light norm EN60598. Products with the ENEC test mark are conforming to the guide line 2006/95/EG. Products with additional safety remarks (e.g protection class, IP) are identified within the product family with the relevant symbol and number. The content of this catalogue is protected under copyright law for EGLO Leuchten GmbH. All rights reserved. Our specific written consent must be obtained before using any illustrations and texts. The pictures are 4C prints and may differ from the original.

The product pictures and ambiances in this catalogue can deviate from reality, and they do not necessarily concur with the usual application of the product. EGLO does not assume liability for the correctness, completeness or the application depiction of the products and/or the product information.

Design, layout and composition: EGLO GmbH, A-6136 Pöll - AUSTRIA

Print: Samson Druck GmbH, 5581 St. Margarethen - AUSTRIA

Pictures: EGLO, Adobe Stock, istockphoto.com

Mit diesem Katalog verlieren alle vorhergehenden Kataloge und Preislisten ihre Gültigkeit. Irrtümer, Druckfehler, Modell- und Preisänderungen sowie technische Änderungen vorbehalten. Wir liefern zu unseren Liefer- und Zahlungsbedingungen. Unsere Produkte entsprechen der europäischen Leuchtnorm EN 60598. Produkte mit dem ENEC Prüfzeichen sind konform mit der Richtlinie 2006/95/EG. Produkte mit weiteren Sicherheitshinweisen (zB. Schutzklasse, IP) sind mit Symbol und Zahl bei der Produktfamilie ausgezeichnet. Der Inhalt dieses Kataloges ist für die EGLO Leuchten GmbH urheberrechtlich geschützt. Alle Rechte sind vorbehalten. Bilder und Texte dürfen nicht ohne vorherige ausdrückliche, schriftliche Genehmigung verwendet werden. Die Abbildungen sind 4C Drucke und können vom Original abweichen.

Die Katalogbilder und die gezeigten Darstellungen der Produkte können von der Wirklichkeit abweichen und nicht den üblichen Produktanwendungen entsprechen. EGLO übernimmt keine Haftung für die Richtigkeit, Vollständigkeit und Anwendungsdarstellung der Produkte und Produktinformationen.

Gestaltung, Layout und Satz: EGLO GmbH, A-6136 Pöll - AUSTRIA

Druck: Samson Druck GmbH, 5581 St. Margarethen - AUSTRIA

Bilder: EGLO, Adobe Stock, istockphoto.com

Le présent catalogue remplace tous les catalogues et tarifs précédents. Sous réserve d'erreurs, de fautes d'impression, de modification des modèles et de changement de prix et de technique. Nous livrons sur la base de nos conditions de livraison et de paiement. Nos produits sont conformes aux normes européennes EN 60598 et portent le marquage CE. Les produits portant la marque ENEC sont conformes à la Directive 2006/95/EG. Les produits portant d'autres indications de sécurité (par exemple classe de protection, IP) sont identifiés par le symbole et le nombre correspondants dans la famille de produits.

Le contenu du présent catalogue est protégé pour la société EGLO Leuchten GmbH par un copyright. Tous droits réservés. Toute reproduction d'images et du texte est interdite sans autorisation explicite par écrit préalable. Les images sont imprimées en 4C et peuvent différer de l'original.

Les images des produits et les ambiances dans le catalogue peuvent dévier de la réalité et ne sont pas nécessairement en ligne avec l'usage habituel du produit. EGLO n'engage pas sa responsabilité sur la justesse des images et sur les informations relatives à l'usage pouvant être fait des produits.

Conception, maquette et composition: EGLO GmbH, A-6136 Pöll - AUSTRIA

Presse: Samson Druck GmbH, 5581 St. Margarethen - AUSTRIA

Images: EGLO, Adobe Stock, istockphoto.com

12-2019



EGLO
my light | my style

EGLO Leuchten GmbH
Heiligkreuz 22
A-6136 Pill
Austria
Tel. +43 (0) 5242 6996
Fax +43 (0) 5242 6996-972
info@eglo.com
www.eglo.com

KATA20

my light | my style